



**ASCOT**  
COMMERCIAL

2024-2025  
CATALOGUE



Warranty period for chairs and lounges



Weight rating for individual chairs and lounges\*



Fully imported Chairs, lounges, parts and components.



The Performance criteria adopted for certification by Furntech is based on Australian standards, e.g. Level 6 - Severe commercial and heavy industrial.\*

*\*Weight limits are self-rated by Style Ergonomic Australia. AFRDI approved chairs are normally rated to 110kg.*

AFRDI 142 Certification



AFRDI rating for multi shift use and 160kg weight limit.



Furntech is an independent not-for-profit technical organisation providing standards, testing product certification and research for buyers and sellers of furniture.



BIFMA is a third-party certification program that provides manufacturers with valuable feedback for evaluating the environmental, human, and social impacts of their furniture products for manufacturing, facility, and organisation.



All instructions of use are instructed while sitting in the chair.

# CONTENTS

## R1 - TASK MESH SEATING

Avoca range.....	4
Vesta range .....	6
Chelsea range .....	8
Mega range.....	10

## R2 - TASK SEATING

Prestige range.....	12
Oriel range .....	14
Alpha range .....	16
Virgo range .....	18
Safari range.....	20
Galaxy range.....	22
Profile range .....	24
Epic range.....	26
Spiral range.....	28
Comfort range .....	30
Molta range .....	32

## R3 - MULTI SHIFT SEATING

Rotary range.....	34
Balance range .....	36
Multi range.....	38
Rover range.....	40
Dueler range.....	42
Control range.....	44

## R4 - EXECUTIVE SEATING

Regal range.....	46
Venti range.....	48
Avanti range .....	50
Kombo range .....	52
Assist range.....	54

## R5 - HOSPITALITY SEATING

Focus range.....	56
Vinn range.....	58
Pod range .....	60
Maxi range .....	64
Vera range .....	66

## R6 - BEAM SEATING

Maxi beam .....	68
Focus beam.....	69
Vinn beam .....	70
Pod beam .....	71

## R7 - BREAKOUT SEATING

Smoke range .....	72
Sal range .....	74
Lush range.....	75
Cuppa range.....	76
Vero range.....	77
Gold range .....	78
June range.....	80
Time range .....	81
Opera range.....	82
Leaf range.....	83

## R8 - OTTMANS

Play range.....	84
Ola range .....	85
Clip range .....	86
Impress range .....	87
Radius range.....	88

## R9 - BAR STOOLS

Gamma.....	89
Lift .....	89
Vegas.....	89
Flow .....	89

## R10 - SOFT SEATING

Blitz range.....	90
Twist range.....	91
Montage range.....	92
Concept range .....	93
Shell range .....	94

## R11 - ACOUSTIC SCREENS

Acoustic screens.....	95
-----------------------	----

## R12 - INDUSTRIAL STOOLS

State range.....	96
------------------	----

## FABRIC OPTIONS

Fabric options .....	97
----------------------	----

# AVOCA RANGE

## INSTRUCTION OF USE

To adjust back height hold back with two hands while seated and raise to desired height

To lower the back height raise back all the way to the top and release slowly

### **RIGHT BACK LEVER**

To adjust back angle

### **RIGHT FRONT LEVER**

To adjust seat height

### **600MM BLACK NYLON 5 STAR BASE WITH CASTORS**

Use soft tyred castors for tiles  
Use hard tyred castors for carpet



**INDOOR USE ONLY**

**OPTIONAL  
ADJUSTABLE ARMS**

### **LEFT LEVER**

To adjust seat angle

**X** Do not use as a step ladder

## DIMENSIONS: (mm)

### **LOW BACK**

W: 430

H: 450

### **LOW BACK TO FLOOR**

Lowest: 925

Highest: 1120

### **HIGH BACK**

W: 455

H: 530

### **HIGH BACK TO FLOOR**

Lowest: 1010

Highest: 1210

### **SEAT**

W: 500

D: 460

### **SEAT TO FLOOR**

Lowest: 485

Highest: 625

### **ARM TO FLOOR**

Lowest: 630

Highest: 840

Fabric: Chelsea Sunflower



MAV350H



MAV350



MAV200

Optional:



Drafting kit



Adjustable arm



Colour mesh (Jazz mesh)

## Features:

Adjustable seat height  
Adjustable back height (ratchet)  
Adjustable seat angle (with 3 lever mechanism only)  
Adjustable back angle

Optional 2 or 3 lever mechanism  
Moulded seat foam  
Mesh back  
Java seat

600mm black nylon 5 star base  
Available in local fabrics  
AFRDI tested to level 6  
Suitable for indoor use only



# VESTA RANGE

## INSTRUCTION OF USE

To adjust back height hold back with two hands while seated and raise to desired height

To lower the back height raise back all the way to the top and release slowly

### **RIGHT BACK LEVER**

To adjust back angle

### **RIGHT FRONT LEVER**

To adjust seat height

### **660MM BLACK NYLON 5 STAR BASE WITH CASTORS**

Use soft tyred castors for tiles  
Use hard tyred castors for carpet



**INDOOR USE ONLY**

**OPTIONAL  
ADJUSTABLE ARMS**

### **LEFT LEVER**

To adjust seat angle

**X** Do not use as a step ladder

## DIMENSIONS: (mm)

### **LOW BACK**

W: 430

H: 450

### **LOW BACK TO FLOOR**

Lowest: 930

Highest: 1130

### **HIGH BACK**

W: 455

H: 530

### **HIGH BACK TO FLOOR**

Lowest: 995

Highest: 1205

### **SEAT**

W: 500

D: 480

### **SEAT TO FLOOR**

Lowest: 480

Highest: 600

### **ARM TO FLOOR**

Lowest: 660

Highest: 860

Fabric: Chelsea turpentine



MVE350H



MVE350



MVE200

Optional:



Drafting kit



Adjustable arm



Colour mesh (Jazz mesh)

## Features:

Adjustable seat height  
Adjustable back height (ratchet)  
Adjustable seat angle  
(with 3 lever mechanism only)  
Adjustable back angle

Optional 2 or 3 lever mechanism  
Moulded seat foam  
Mesh back  
Square seat

660mm black nylon 5 star base  
Available in local fabrics  
AFRDI tested to level 6  
Suitable for indoor use only



# CHELSEA RANGE

INDOOR USE ONLY

## INSTRUCTION OF USE

To adjust back height hold back with two hands while seated and raise to desired height

To lower the back height raise back all the way to the top and release slowly

**RIGHT BACK LEVER**  
To adjust back angle

**RIGHT MIDDLE LEVER**  
To adjust seat angle

**RIGHT FRONT LEVER**  
To adjust seat height

**700MM BLACK NYLON 5 STAR BASE WITH CASTORS**

Use soft tyred castors for tiles  
Use hard tyred castors for carpet

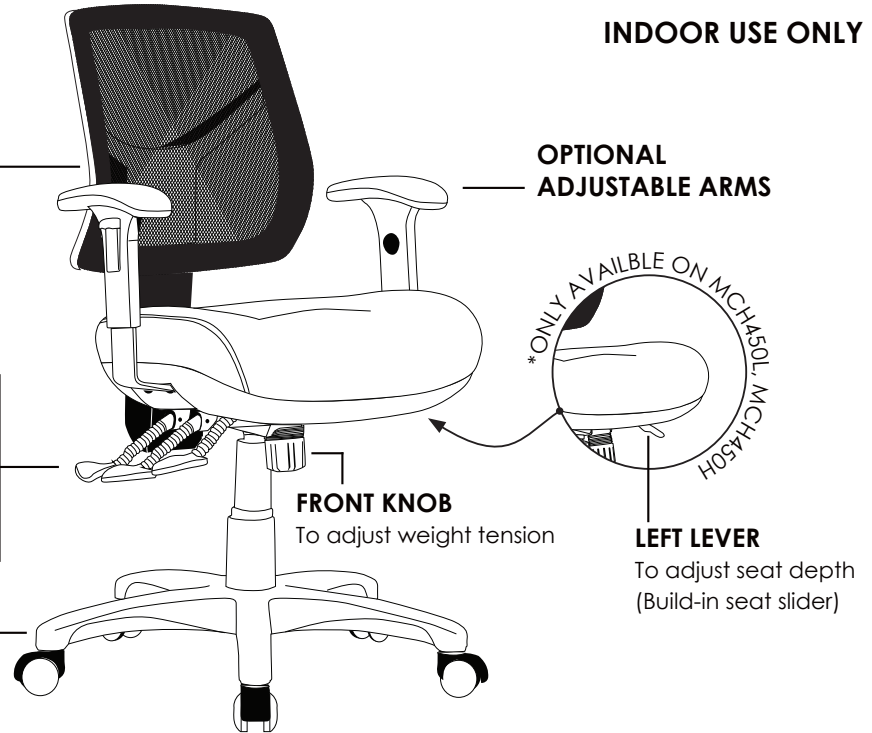

**X** Do not use as a step ladder

## DIMENSIONS: (mm)

### LOW BACK LOW BACK TO FLOOR

W: 430      Lowest: 935  
H: 450      Highest: 1070

### HIGH BACK HIGH BACK TO FLOOR

W: 455      Lowest: 1000  
H: 530      Highest: 1150

### SEAT

W: 530  
D: 480

### SEAT TO FLOOR

Lowest: 510  
Highest: 590

### ARM TO FLOOR

Lowest: 660  
Highest: 810

Fabric: Chelsea anemone



MCH450H



MCH600H



MCH600L

Optional:



Drafting kit\*  
\*Not available  
in 450 Range



Adjustable  
arm



Colour mesh  
(Jazz mesh)

## Features:

Adjustable seat height  
Adjustable back height (ratchet)  
Adjustable seat and back angle  
Adjustable weight tension

Adjustable seat depth (build-in seat slider)  
(with MCH450L, MCH450H only)  
Moulded seat foam  
Mesh back  
Big boy seat

700mm black nylon 5 star base  
Available in local fabrics  
AFRDI tested to level 6  
Suitable for indoor use only



# MEGA RANGE

## INSTRUCTION OF USE

To adjust back height hold back with two hands while seated and raise to desired height

To lower the back height raise back all the way to the top and release slowly

**RIGHT BACK LEVER**  
To adjust back angle

**RIGHT MIDDLE LEVER**  
To adjust seat angle

**RIGHT FRONT LEVER**  
To adjust seat height

**700MM BLACK NYLON 5 STAR BASE WITH CASTORS**

Use soft tyred castors for tiles  
Use hard tyred castors for carpet



**INDOOR USE ONLY**

**OPTIONAL  
ADJUSTABLE ARMS**

**FRONT KNOB**  
To adjust weight tension

**X Do not use as a step ladder**

## DIMENSIONS: (mm)

### **BACK**

W: 450

H: 530

### **BACK TO FLOOR**

Lowest: 1025

Highest: 1150

### **SEAT**

W: 560

D: 510

### **SEAT TO FLOOR**

Lowest: 520

Highest: 600

### **ARM TO FLOOR**

Lowest: 665

Highest: 830

Fabric: Chelsea mint



MEGA



MEGA-C



back view

Optional:



Colour mesh  
(Jazz mesh)

Features:

Adjustable seat height  
Adjustable back height (ratchet)  
Adjustable seat and back angle  
Adjustable weight tension

Moulded seat foam  
Mesh back  
Mega big boy seat  
3 lever heavy duty ergonomic mechanism

700mm black nylon 5 star base  
Available in local fabrics  
AFRDI tested to level 6  
Suitable for indoor use only



# PRESTIGE RANGE

## INSTRUCTION OF USE

**INDOOR USE ONLY**

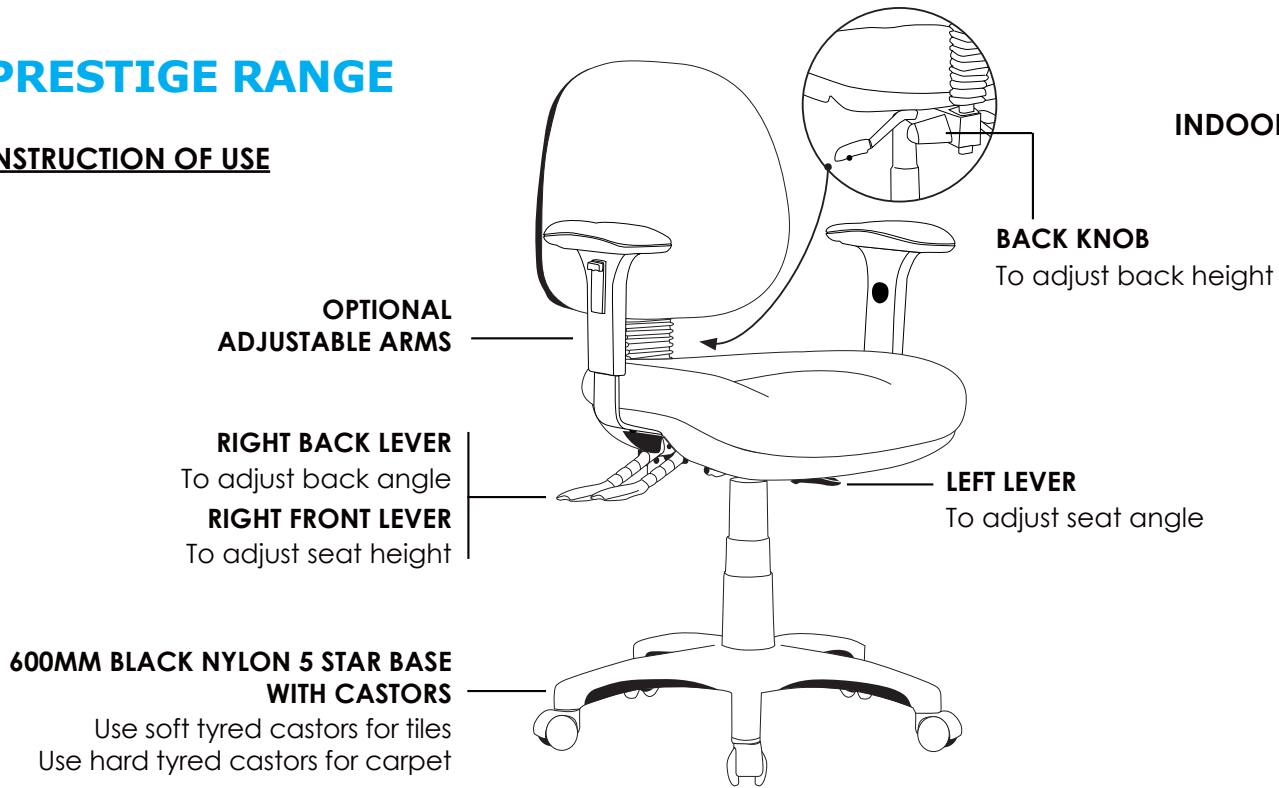

**X** Do not use as a step ladder

## DIMENSIONS: (mm)

### **LOW BACK    LOW BACK TO FLOOR**

W: 440    Lowest: 860  
H: 400    Highest: 1045

### **HIGH BACK    HIGH BACK TO FLOOR**

W: 450    Lowest: 950  
H: 510    Highest: 1150

### **SEAT**

W: 500  
D: 460

### **SEAT TO FLOOR**

Lowest: 480  
Highest: 625

### **ARM TO FLOOR**

Lowest: 630  
Highest: 840

Fabric: Chelsea daisy



P350H



P350



P200

Optional:



Drafting kit



Adjustable arm

## Features:

Adjustable seat height  
Adjustable back height  
Adjustable seat angle  
(with 3 lever mechanism only)

Adjustable back angle  
Optional 2 or 3 lever mechanism  
Moulded seat and back foam  
Java seat

600mm black nylon 5 star base  
Available in local fabrics  
AFRDI tested to level 6  
Suitable for indoor use only



# ORIEL RANGE

## INSTRUCTION OF USE

To adjust back height hold back with two hands while seated and raise to desired height

To lower the back height raise back all the way to the top and release slowly

**RIGHT BACK LEVER**  
To adjust back angle

**RIGHT FRONT LEVER**  
To adjust seat height

**600MM BLACK NYLON 5 STAR BASE WITH CASTORS**

Use soft tyred castors for tiles  
Use hard tyred castors for carpet

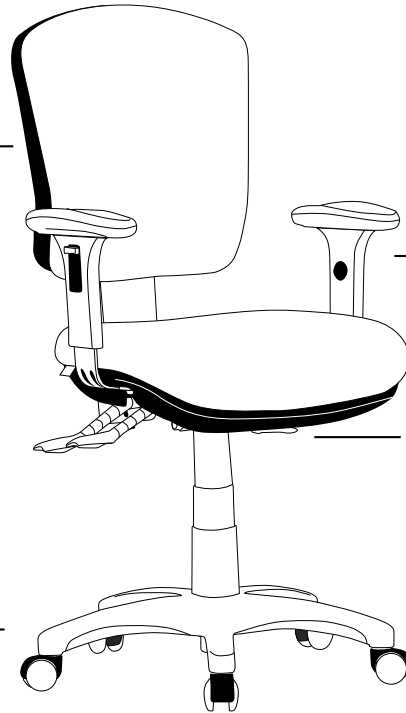

**INDOOR USE ONLY**

**OPTIONAL  
ADJUSTABLE ARMS**

**LEFT LEVER**  
To adjust seat angle

**X** Do not use as a step ladder

## DIMENSIONS: (mm)

**LOW BACK LOW BACK TO FLOOR**

W: 460    Lowest: 850  
H: 440    Highest: 1060

**HIGH BACK HIGH BACK TO FLOOR**

W: 470    Lowest: 950  
H: 540    Highest: 1170

**SEAT**

W: 500  
D: 460

**SEAT TO FLOOR**

Lowest: 485  
Highest: 625

**ARM TO FLOOR**

Lowest: 630  
Highest: 840

Fabric: Chelsea ryegrass



OR350H



OR350



OR200

Optional:



Drafting kit



Adjustable arm

## Features:

Adjustable seat height  
Adjustable back height (ratchet)  
Adjustable seat angle  
(with 3 lever mechanism only)

Adjustable back angle  
Optional 2 or 3 lever mechanism  
Moulded seat and back foam  
Java seat

600mm black nylon 5 star base  
Available in local fabrics  
AFRDI tested to level 6  
Suitable for indoor use only



# ALPHA RANGE

## INSTRUCTION OF USE

To adjust back height hold back with two hands while seated and raise to desired height

To lower the back height raise back all the way to the top and release slowly

**RIGHT BACK LEVER**  
To adjust back angle

**RIGHT FRONT LEVER**  
To adjust seat height

**600MM BLACK NYLON 5 STAR BASE WITH CASTORS**

Use soft tyred castors for tiles  
Use hard tyred castors for carpet



**INDOOR USE ONLY**

**OPTIONAL  
ADJUSTABLE ARMS**

**LEFT LEVER**  
To adjust seat angle

**X Do not use as a step ladder**

## DIMENSIONS: (mm)

### **LOW BACK LOW BACK TO FLOOR**

W: 440    Lowest: 935  
H: 460    Highest: 1120

### **HIGH BACK HIGH BACK TO FLOOR**

W: 450    Lowest: 1020  
H: 560    Highest: 1240

### **SEAT**

W: 500  
D: 460

### **SEAT TO FLOOR**

Lowest: 485  
Highest: 625

### **ARM TO FLOOR**

Lowest: 630  
Highest: 840

Fabric: Chelsea laurel



AL350H



AL350



AL200

Optional:



Drafting kit



Adjustable arm

## Features:

Adjustable seat height  
Adjustable back height (ratchet)  
Adjustable seat angle  
(with 3 lever mechanism only)

Adjustable back angle  
Optional 2 or 3 lever mechanism  
Moulded seat and back foam  
Java seat

600mm black nylon 5 star base  
Available in local fabrics  
AFRDI tested to level 6  
Suitable for indoor use only



# VIRGO RANGE

## INSTRUCTION OF USE

To adjust back height hold back with two hands while seated and raise to desired height

To lower the back height raise back all the way to the top and release slowly

**RIGHT BACK LEVER**  
To adjust back angle

**RIGHT FRONT LEVER**  
To adjust seat height

**660MM BLACK NYLON 5 STAR BASE WITH CASTORS**

Use soft tyred castors for tiles  
Use hard tyred castors for carpet

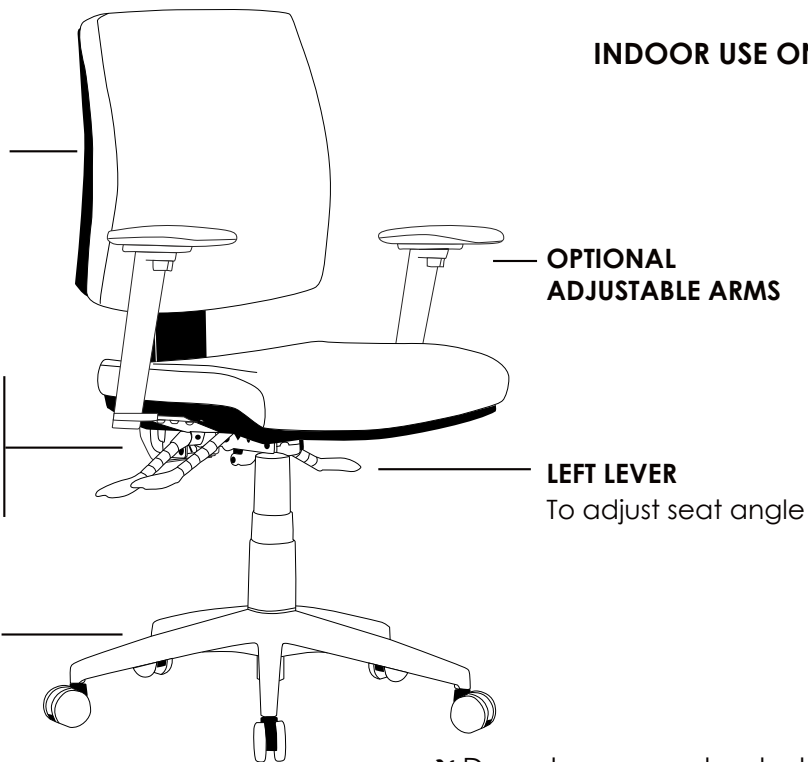

**INDOOR USE ONLY**

**X Do not use as a step ladder**

## DIMENSIONS: (mm)

### **LOW BACK LOW BACK TO FLOOR**

W: 440    Lowest: 900  
H: 460    Highest: 1110

### **HIGH BACK HIGH BACK TO FLOOR**

W: 450    Lowest: 910  
H: 560    Highest: 1120

### **SEAT**

W: 500  
D: 480

### **SEAT TO FLOOR**

Lowest: 480  
Highest: 600

### **ARM TO FLOOR**

Lowest: 660  
Highest: 860

Fabric: Chelsea slate



VI350H



VI350



VI200

Optional:



Drafting kit



Adjustable arm

## Features:

Adjustable seat height  
Adjustable back height (ratchet)  
Adjustable seat angle  
(with 3 lever mechanism only)

Adjustable back angle  
Optional 2 or 3 lever mechanism  
Moulded seat and back foam  
Square seat

660mm black nylon 5 star base  
Available in local fabrics  
AFRDI tested to level 6  
Suitable for indoor use only



# SAFARI RANGE

## INSTRUCTION OF USE

To adjust back height hold back with two hands while seated and raise to desired height

To lower the back height raise back all the way to the top and release slowly

### **RIGHT BACK LEVER**

To adjust back angle

### **RIGHT FRONT LEVER**

To adjust seat height

### **700MM BLACK NYLON 6 STAR BASE WITH CASTORS**

Use soft tyred castors for tiles  
Use hard tyred castors for carpet

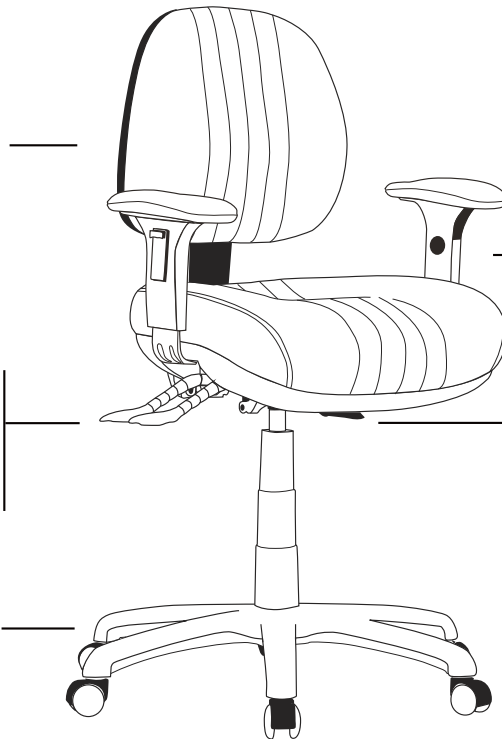

**INDOOR USE ONLY**

**OPTIONAL  
ADJUSTABLE ARMS**

**LEFT LEVER**

To adjust seat angle

**X** Do not use as a step ladder

## DIMENSIONS: (mm)

### **LOW BACK    LOW BACK TO FLOOR**

W: 440    Lowest: 930  
H: 400    Highest: 1140

### **HIGH BACK    HIGH BACK TO FLOOR**

W: 450    Lowest: 990  
H: 510    Highest: 1185

### **SEAT**

W: 530  
D: 480

### **SEAT TO FLOOR**

Lowest: 530  
Highest: 670

### **ARM TO FLOOR**

Lowest: 670  
Highest: 880

Fabric: Chelsea bark



SA350H



SA350



SA200

Optional:



Drafting kit



Adjustable arm

## Features:

Adjustable seat height  
Adjustable back height (ratchet)  
Adjustable seat angle  
(with 3 lever mechanism only)

Adjustable back angle  
Optional 2 or 3 lever mechanism  
Moulded seat and back foam  
Firm kidney and lumbar support

Big boy seat  
700mm black nylon 6 star base  
Available in local fabrics  
Suitable for indoor use only



# GALAXY RANGE

**INDOOR USE ONLY**

## INSTRUCTION OF USE

To adjust back height hold back with two hands while seated and raise to desired height

To lower the back height raise back all the way to the top and release slowly

### **RIGHT BACK LEVER**

To adjust back angle

### **RIGHT MIDDLE LEVER**

To adjust seat angle

### **RIGHT FRONT LEVER**

To adjust seat height

### **700MM BLACK NYLON 5 STAR BASE WITH CASTORS**

Use soft tyred castors for tiles  
Use hard tyred castors for carpet

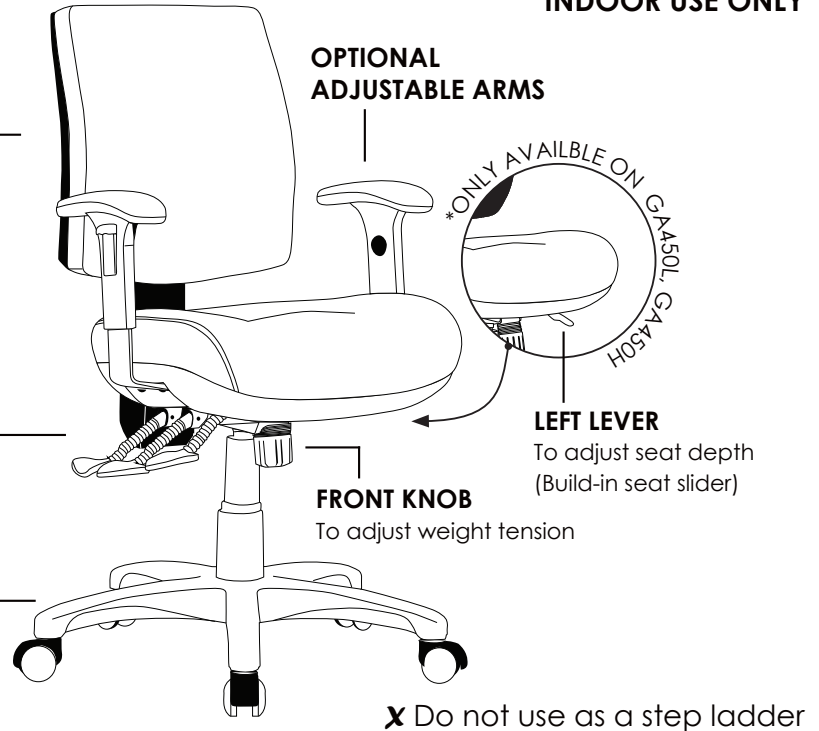

## DIMENSIONS: (mm)

### **LOW BACK LOW BACK TO FLOOR**

W: 440    Lowest: 920  
H: 460    Highest: 1070

### **HIGH BACK HIGH BACK TO FLOOR**

W: 450    Lowest: 1020  
H: 560    Highest: 1155

### **SEAT**

W: 530  
D: 480

### **SEAT TO FLOOR**

Lowest: 525  
Highest: 605

### **ARM TO FLOOR**

Lowest: 670  
Highest: 815

Fabric: Chelsea lobelia



GA450H



GA600H



GA600L

Optional:



Drafting kit  
\*Not available  
in 450 Range



Adjustable  
arm

## Features:

Adjustable seat height  
Adjustable back height (ratchet)  
Adjustable seat and back angle  
Adjustable weight tension

Adjustable seat depth (build-in seat slider)  
(with GA450L, GA450H only)  
Moulded seat and back foam  
Big boy seat

700mm black nylon 5 star base  
Available in local fabrics  
AFRDI tested to level 6  
Suitable for indoor use only



# PROFILE RANGE

## INSTRUCTION OF USE

To adjust back height hold back with two hands while seated and raise to desired height

To lower the back height raise back all the way to the top and release slowly

### **RIGHT BACK LEVER**

To adjust back angle

### **RIGHT MIDDLE LEVER**

To adjust seat angle

### **RIGHT FRONT LEVER**

To adjust seat height

### **700MM BLACK NYLON 5 STAR BASE WITH CASTORS**

Use soft tyred castors for tiles  
Use hard tyred castors for carpet

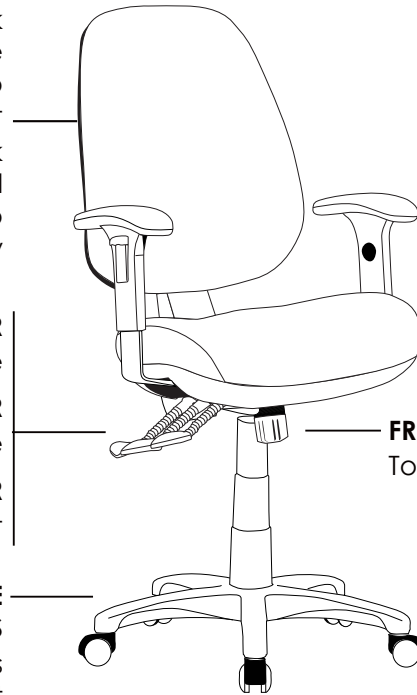

**INDOOR USE ONLY**

**OPTIONAL  
ADJUSTABLE ARMS**

**FRONT KNOB**  
To adjust weight tension

**X** Do not use as a step ladder

## DIMENSIONS: (mm)

### **BACK**

W: 490

H: 580

### **BACK TO FLOOR**

Lowest: 1025

Highest: 1175

### **SEAT**

W: 530

D: 480

### **SEAT TO FLOOR**

Lowest: 525

Highest: 605

### **ARM TO FLOOR**

Lowest: 670

Highest: 815

Fabric: Chelsea crocus



PR600



PR600C



back view

Optional:



Drafting kit

## Features:

Adjustable seat height  
Adjustable back height (ratchet)  
Adjustable seat and back angle  
Adjustable weight tension

Moulded seat and back foam  
Big boy seat  
3 lever heavy duty ergonomic mechanism  
700mm black nylon 5 star base



Available in local fabrics  
AFRDI tested to level 6  
Suitable for indoor use only

# EPIC RANGE

## INSTRUCTION OF USE

To adjust back height hold back with two hands while seated and raise to desired height

To lower the back height raise back all the way to the top and release slowly

**RIGHT BACK LEVER**  
To adjust back angle

**RIGHT MIDDLE LEVER**  
To adjust seat angle

**RIGHT FRONT LEVER**  
To adjust seat height

**700MM BLACK NYLON 5 STAR BASE WITH CASTORS**

Use soft tyred castors for tiles  
Use hard tyred castors for carpet



**INDOOR USE ONLY**

**OPTIONAL  
ADJUSTABLE ARMS**

**FRONT KNOB**  
To adjust weight tension

**X Do not use as a step ladder**

## DIMENSIONS: (mm)

### **BACK**

W: 490

H: 580

### **BACK TO FLOOR**

Lowest: 1080

Highest: 1240

### **SEAT**

W: 560

D: 510

### **SEAT TO FLOOR**

Lowest: 520

Highest: 600

### **ARM TO FLOOR**

Lowest: 665

Highest: 830

Fabric: Chelsea eryngo



EPIC



EPIC-C



back view

### Features:

Adjustable seat height  
Adjustable back height (ratchet)  
Adjustable seat and back angle  
Adjustable weight tension

Moulded seat and back foam  
Mega big boy seat  
3 lever heavy duty ergonomic mechanism  
700mm black nylon 5 star base



Available in local fabrics  
AFRDI tested to level 6  
Suitable for indoor use only

# SPIRAL RANGE

## INSTRUCTION OF USE

To adjust back height hold back with two hands while seated and raise to desired height

To lower the back height raise back all the way to the top and release slowly

**RIGHT BACK LEVER**  
To adjust back angle

**RIGHT MIDDLE LEVER**  
To adjust seat angle

**RIGHT FRONT LEVER**  
To adjust seat height

### **700MM BLACK NYLON 5 STAR BASE WITH CASTORS**

Use soft tyred castors for tiles  
Use hard tyred castors for carpet



**INDOOR USE ONLY**

**X** Do not use as a step ladder

## DIMENSIONS: (mm)

### **BACK**

W: 460

H: 560

### **BACK TO FLOOR**

Lowest: 1025

Highest: 1165

### **SEAT**

W: 560

D: 510

### **SEAT TO FLOOR**

Lowest: 520

Highest: 600

### **ARM TO FLOOR**

Lowest: 665

Highest: 830

Fabric: Chelsea olive



SPIRAL



SPIRAL-C



back view

Features:

Adjustable seat height  
Adjustable back height (ratchet)  
Adjustable seat and back angle  
Adjustable weight tension

Moulded seat and back foam  
Mega big boy seat  
3 lever heavy duty ergonomic mechanism  
700mm black nylon 5 star base

Available in local fabrics  
AFRDI tested to level 6  
Suitable for indoor use only



## COMFORT RANGE

### INSTRUCTION OF USE

To adjust back height hold back with two hands while seated and raise to desired height

To lower the back height raise back all the way to the top and release slowly

**RIGHT BACK LEVER**  
To adjust back angle

**RIGHT MIDDLE LEVER**  
To adjust seat angle

**RIGHT FRONT LEVER**  
To adjust seat height

### **700MM BLACK NYLON 6 STAR BASE WITH CASTORS**

Use soft tyred castors for tiles  
Use hard tyred castors for carpet



**INDOOR USE ONLY**

**OPTIONAL  
ADJUSTABLE ARMS**

**FRONT KNOB**  
To adjust weight tension

**X** Do not use as a step ladder

### DIMENSIONS: (mm)

#### **BACK**

W: 470

H: 550

#### **BACK TO FLOOR**

Lowest: 1050

Highest: 1190

#### **SEAT**

W: 560

D: 510

#### **SEAT TO FLOOR**

Lowest: 530

Highest: 600

#### **ARM TO FLOOR**

Lowest: 660

Highest: 800



COMFORT



COMFORT-C

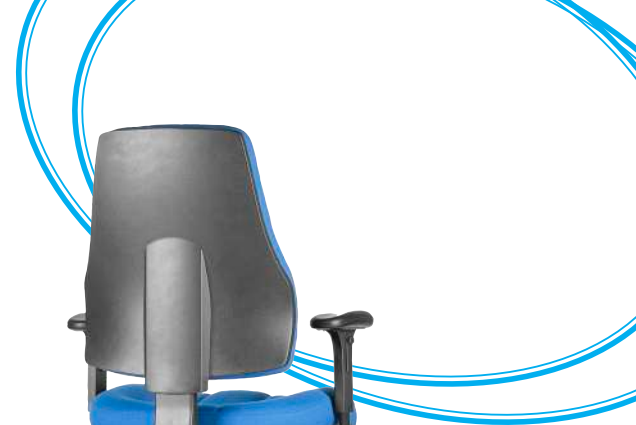

back view

Features:

Adjustable seat height  
Adjustable back height (ratchet)  
Adjustable seat and back angle  
Adjustable weight tension

Moulded seat and back foam  
Mega big boy seat  
3 lever heavy duty ergonomic mechanism  
700mm black nylon 6 star base

Available in local fabrics  
Suitable for indoor use only

WARRANTY 5 Year  
WEIGHT LIMIT 150 Kilogram  
UPHOLSTERED IN AUSTRALIA

# MOLTA RANGE

## INSTRUCTION OF USE

To adjust back height hold back with two hands while seated and raise to desired height

To lower the back height raise back all the way to the top and release slowly

**RIGHT BACK LEVER**  
To adjust back angle

**RIGHT MIDDLE LEVER**  
To adjust seat angle

**RIGHT FRONT LEVER**  
To adjust seat height

**700MM BLACK NYLON 6 STAR BASE WITH CASTORS**

Use soft tyred castors for tiles  
Use hard tyred castors for carpet



**INDOOR USE ONLY**

**OPTIONAL  
ADJUSTABLE ARMS**

**FRONT KNOB**  
To adjust weight tension

**X Do not use as a step ladder**

## DIMENSIONS: (mm)

### **BACK**

W: 500

H: 550

### **BACK TO FLOOR**

Lowest: 1050

Highest: 1190

### **SEAT**

W: 560

D: 510

### **SEAT TO FLOOR**

Lowest: 530

Highest: 600

### **ARM TO FLOOR**

Lowest: 660

Highest: 800



MOLTA



MOLTA-C



back view

Features:

Adjustable seat height  
Adjustable back height (ratchet)  
Adjustable seat and back angle  
Adjustable weight tension

Moulded seat and back foam  
Mega big boy seat  
3 lever heavy duty ergonomic mechanism  
700mm black nylon 6 star base

Available in local fabrics  
Suitable for indoor use only



# ROTARY RANGE

INDOOR USE ONLY

## INSTRUCTION OF USE

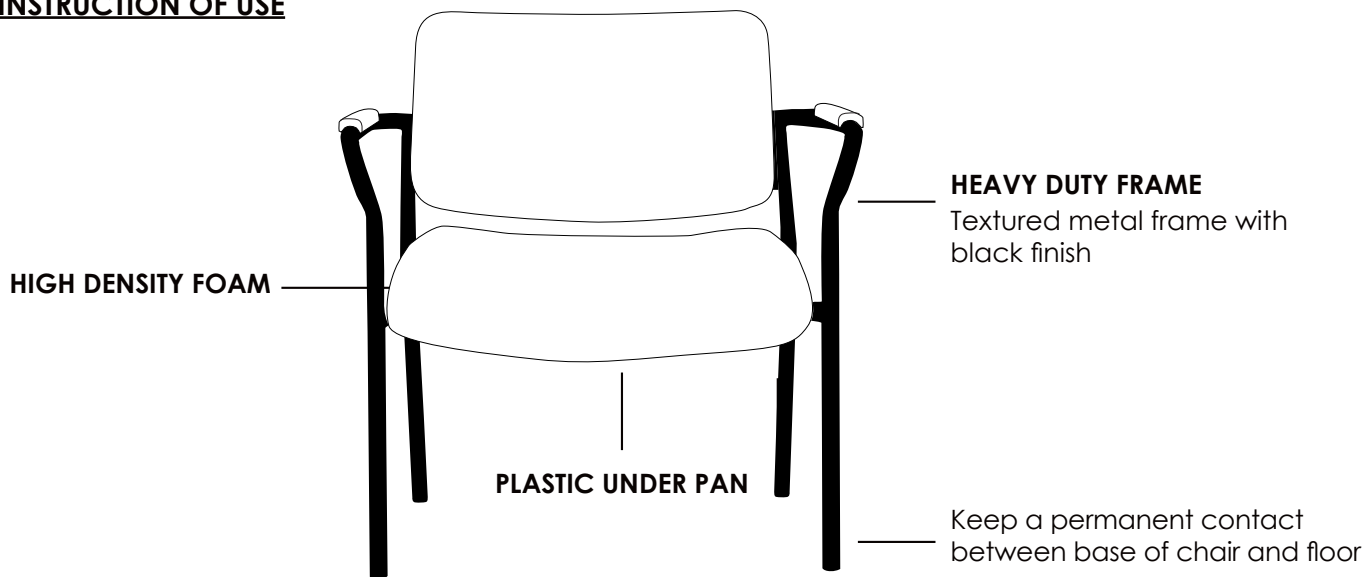

**X** Do not use as a step ladder

### DIMENSIONS: (mm)

600		
BACK	SEAT	OVERALL
W: 600	W: 500	W: 660
H: 330	D: 520	H: 760
		D: 640

700		
BACK	SEAT	OVERALL
W: 700	W: 630	W: 770
H: 330	D: 520	H: 760
		D: 640

SEAT TO FLOOR  
460

ARM TO FLOOR  
630



ROTARY-600



ROTARY-700



back view

Features:

High density foam  
Plastic under pan

Heavy duty black textured metal frame  
Available in local fabrics

Suitable for indoor use only



# BALANCE RANGE

## INSTRUCTION OF USE

**INDOOR USE ONLY**

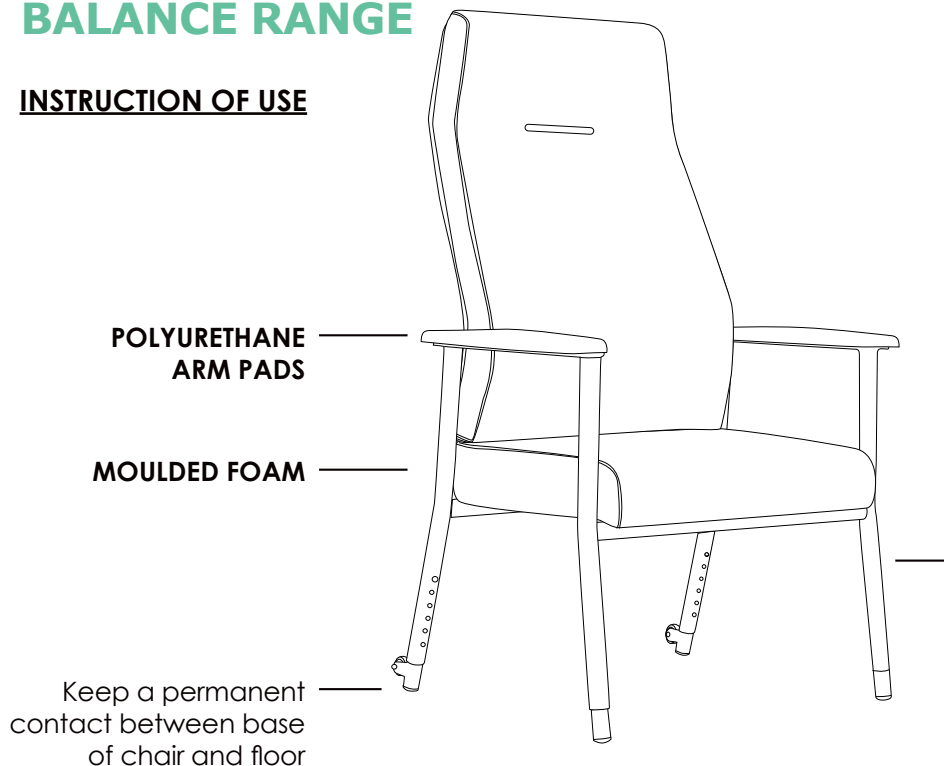

### **ADJUSTABLE HEIGHT**

Please avoid adjusting the chair height whilst you are seated

Carefully tilt the chair onto its back to access the leg height adjustment

While the chair is tilted, press the button to release the tension

With the button engaged, pull the leg extension up or down to your desired height

The wheels located at the back of the chair assist with chair mobility

Do not move the chair while someone is seated, to avoid accidents

**X** Do not use as a step ladder

### DIMENSIONS: (mm)

**H-600  
OVERALL**

W: 645

H: 1130

D: 660

**L-600  
OVERALL**

W: 645

H: 910

D: 660

**H-700  
OVERALL**

W: 745

H: 1130

D: 660

**L-700  
OVERALL**

W: 745

H: 910

D: 660

**LOW BACK  
TO FLOOR**

Lowest: 910

Highest: 1030

**HIGH BACK  
TO FLOOR**

Lowest: 1130

Highest: 1250

**SEAT TO FLOOR**

Lowest: 445

Highest: 565

**ARM TO FLOOR**

Lowest: 665

Highest: 785



BAL-H-700



BAL-H-600



BAL-L-700



BAL-L-600

## Features:

Bariatric chair  
Suitable for age care and hospital use  
Adjustable feet

Polyurethane arm pads  
Moulded seat and back foam

Available in local fabrics  
Suitable for indoor use only



# MULTI RANGE

## INSTRUCTION OF USE

To adjust back height hold back with two hands while seated and raise to desired height

To lower the back height raise back all the way to the top and release slowly (LOW BACK ONLY)

**RIGHT BACK KNOB**  
To adjust seat depth (seat slider)

**RIGHT BACK LEVER**  
To adjust back angle

**RIGHT MIDDLE LEVER**  
To adjust seat angle

**RIGHT FRONT LEVER**  
To adjust seat height

**700MM ALUMINIUM 5 STAR BASE WITH CASTORS**

Use soft tyred castors for tiles  
Use hard tyred castors for carpet



**X** Do not use as a step ladder

## DIMENSIONS: (mm)

LOW BACK		MEDIUM BACK		HEADREST	HIGH BACK TO FLOOR	SEAT	SEAT TO FLOOR	ARM TO FLOOR
BACK	BACK TO FLOOR	BACK	BACK TO FLOOR					
W: 500	Lowest: 910	W: 500	Lowest: 1040	W: 345	Lowest: 1180	W: 500	Lowest: 480	Lowest: 660
H: 500	Highest: 1045	H: 660	Highest: 1130	H: 170	Highest: 1360	D: 470	Highest: 570	Highest: 810

\* Please note that the Headrest should not be used to manoeuvre the chair.



MUEX1H



MUEX1M



MUEX1L

### Features:

Adjustable seat height  
Adjustable back height (ratchet)  
(Available in low back only)  
Adjustable seat and back angle

Adjustable seat depth (seat slider)  
Adjustable arms  
Moulded seat foam  
Mesh back

4 lever ergonomic mechanism  
700mm aluminium 5 star base  
Available in local fabrics  
Suitable for indoor use only



# ROVER RANGE

## INSTRUCTION OF USE

To adjust back height hold back with two hands while seated and raise to desired height

To lower the back height raise back all the way to the top and release slowly

**RIGHT FOURTH LEVER**  
To adjust back angle

**RIGHT THIRD LEVER**  
To adjust seat angle

**RIGHT SECOND LEVER**  
To adjust seat height

**RIGHT FRONT LEVER**  
To adjust seat front angle

**700MM BLACK NYLON 5 STAR BASE WITH CASTORS**

Use soft tyred castors for tiles

Use hard tyred castors for carpet



**INDOOR USE ONLY**

**X Do not use as a step ladder**

## DIMENSIONS: (mm)

LOW BACK	BACK TO FLOOR	HIGH BACK	BACK TO FLOOR	SEAT	SEAT TO FLOOR	ARM TO FLOOR
W: 510	Lowest: 980	W: 500	Lowest: 1095	W: 510	Lowest: 480	Lowest: 640
H: 540	Highest: 1140	H: 630	Highest: 1260	D: 520	Highest: 570	Highest: 790

Fabric: Jazz black



ROVER-2HA



ROVER-2LA



back view

### Features:

Adjustable seat height  
Adjustable back height (ratchet)  
Adjustable seat and back angle  
Adjustable weight tension

Adjustable arms  
Moulded seat and back foam  
4 lever ergonomic mechanism

700mm black nylon 5 star base  
Available in local fabrics  
Suitable for indoor use only



# DUELER RANGE

## INSTRUCTION OF USE

**INDOOR USE ONLY**

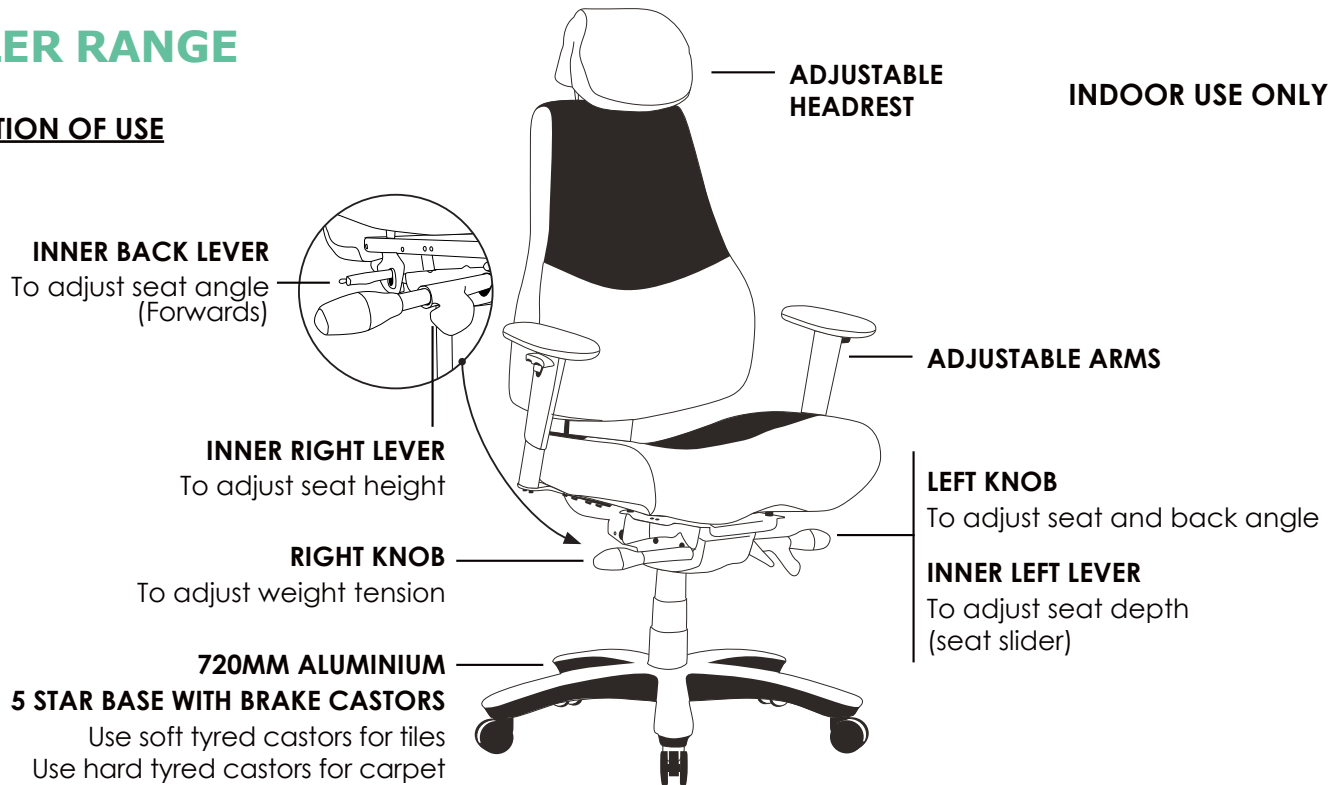

**X** Do not use as a step ladder

### DIMENSIONS: (mm)

#### **BACK WITH HEADREST**

W: 475

H: 720

#### **HEADREST TO FLOOR**

Lowest: 1230

Highest: 1350

#### **SEAT**

W: 515

D: 540

#### **SEAT TO FLOOR**

Lowest: 525

Highest: 645

#### **ARM TO FLOOR**

Lowest: 700

Highest: 920

Fabric: Lana sapphire



DUELER



side view



back view

*\* Please note that the Headrest should not be used to manoeuvre the chair.*

### Features:

Adjustable seat height

Adjustable seat and back angle

Forward seat tilt adjustment

Adjustable seat depth (seat slider)

Adjustable weight tension

Adjustable arms

Adjustable headrest

Moulded seat and back foam

Saddle seat

Synchron mechanism with 3 locking positions

720mm aluminium 5 star base



AFRDI 142 Certification



Brake castors

Available in local fabrics

AFRDI tested to level 6

AFRDI tested to multi shift use 160kg

Suitable for indoor use only

# CONTROL RANGE

INDOOR USE ONLY

## INSTRUCTION OF USE

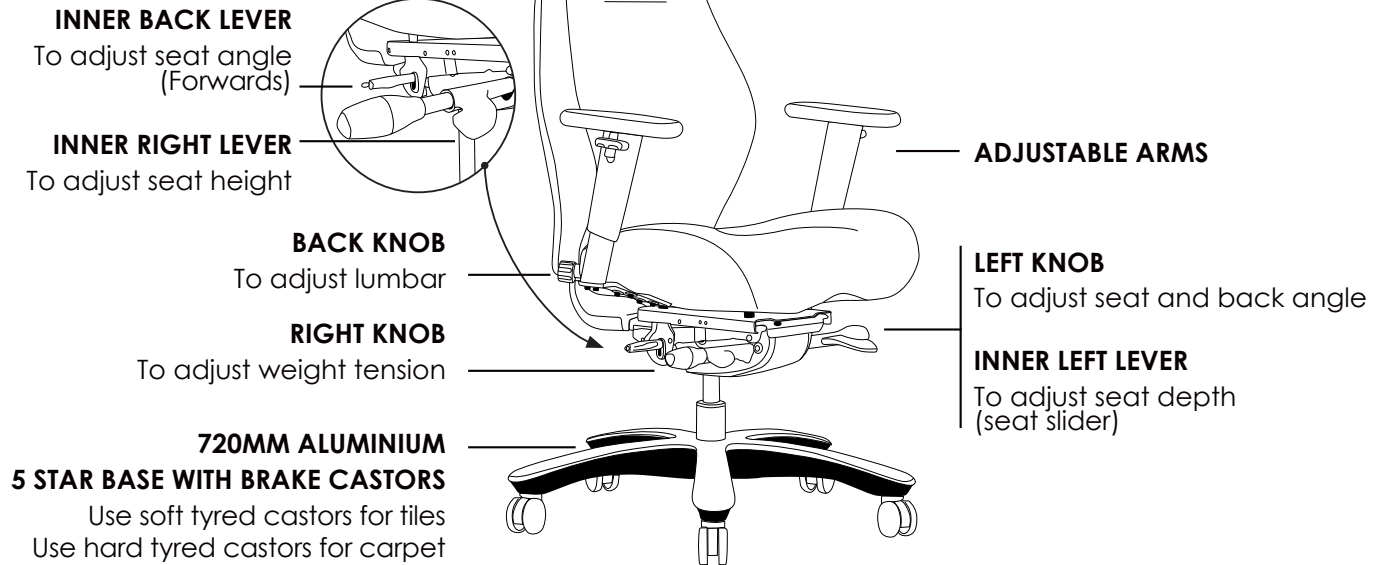

**X** Do not use as a step ladder

## DIMENSIONS: (mm)

**BACK**    **BACK TO FLOOR**  
W: 475    Lowest: 1060  
H: 615    Highest: 1180

**HEADREST**    **HEADREST TO FLOOR**  
W: 260    Lowest: 1240  
H: 180    Highest: 1360

**SEAT**    **SEAT TO FLOOR**  
W: 540    Lowest: 505  
D: 490    Highest: 625

**ARM TO FLOOR**  
Lowest: 675  
Highest: 875



CONTROL-H



CONTROL-L



back view

*\* Please note that the Headrest should not be used to manoeuvre the chair.*

**Features:**

- Adjustable seat height
- Adjustable seat and back angle
- Foward seat tilt adjustment
- Adjustable seat depth (seat slider)
- Adjustable weight tension

- Adjustable lumbar support
- Adjustable arms
- Moulded seat and back foam
- Saddle seat
- Synchron mechanism with 3 locking positions

- 720mm aluminium 5 star base
- Brake castors
- Available in local fabrics
- AFRDI tested to level 6
- Suitable for indoor use only

# REGAL RANGE

## INSTRUCTION OF USE

**INDOOR USE ONLY**

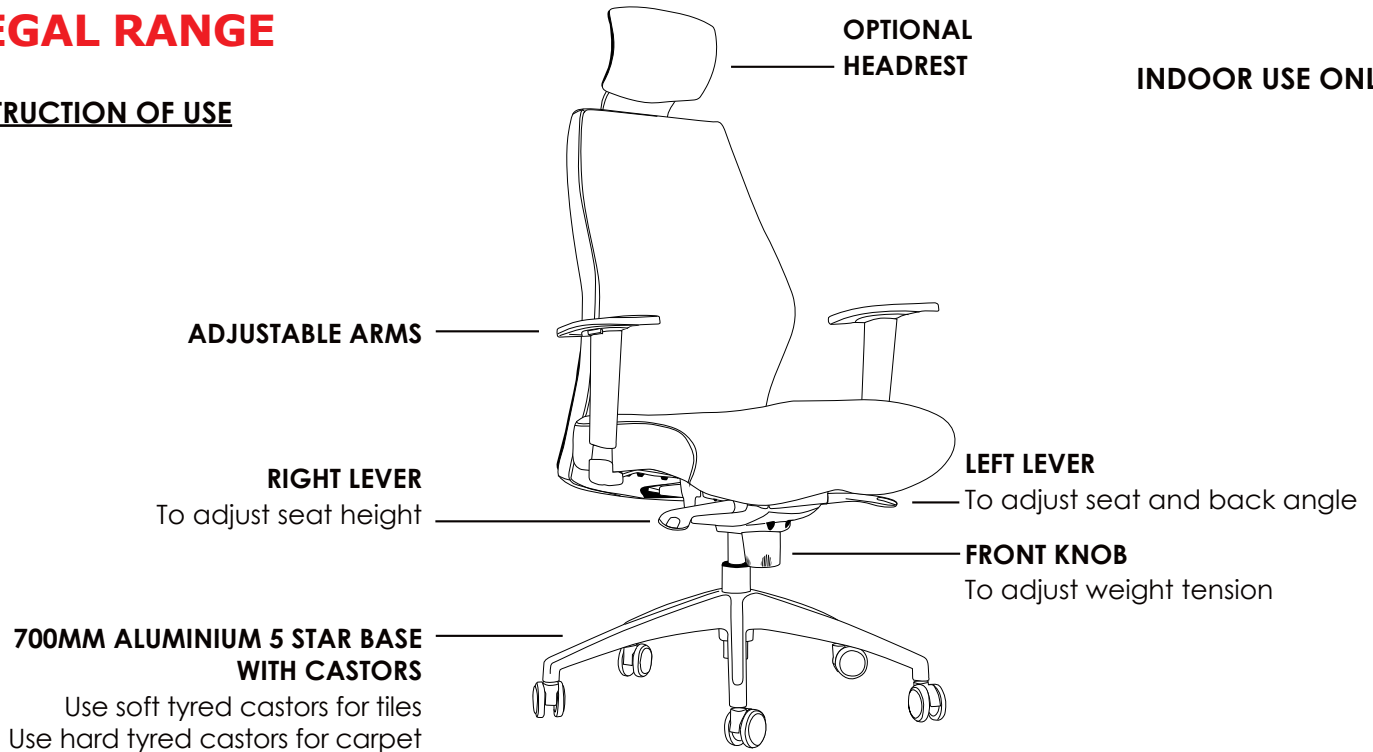

**X** Do not use as a step ladder

### DIMENSIONS: (mm)

**BACK**    **BACK TO FLOOR**  
W: 500    Lowest: 1020  
H: 570    Highest: 1080

**HEADREST**    **HEADREST TO FLOOR**  
W: 260    Lowest: 1210  
H: 180    Highest: 1270

**SEAT**    **SEAT TO FLOOR**  
W: 525    Lowest: 470  
D: 470    Highest: 530

**ARM TO FLOOR**  
Lowest: 640  
Highest: 780



REGAL-H



REGAL-L



back view

*\* Please note that the Headrest should not be used to manoeuvre the chair.*

### Features:

Adjustable seat height  
Adjustable seat and back angle  
Adjustable weight tension  
Adjustable chrome arms

Moulded back foam  
Saddle seat  
Synchron mechanism with 3 locking positions  
700mm aluminium 5 star base

Available in local fabrics  
Suitable for indoor use only



# VENTI RANGE

## INSTRUCTION OF USE

**INDOOR USE ONLY**

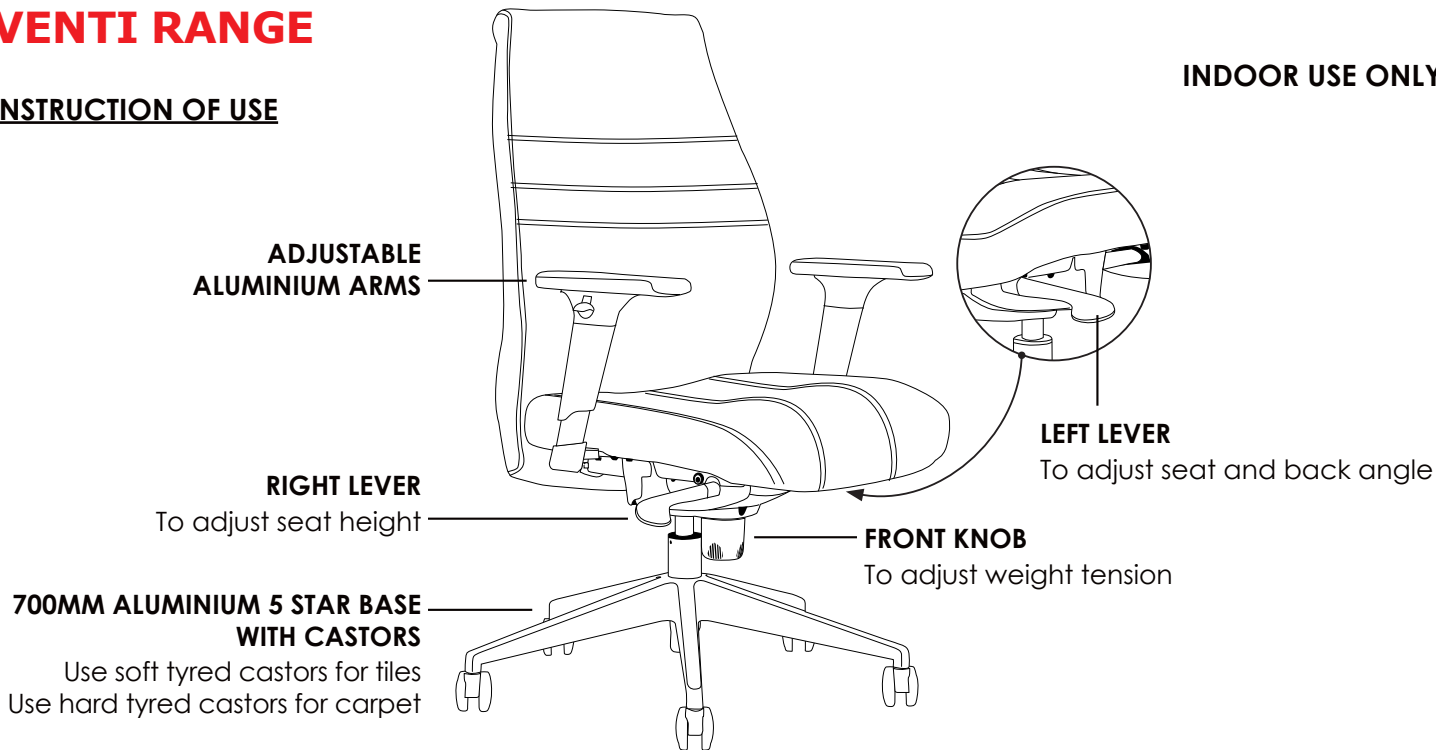

**X** Do not use as a step ladder

## DIMENSIONS: (mm)

**LOW BACK**    **BACK TO FLOOR**  
W: 480    Lowest: 1025  
H: 580    Highest: 1085

**HIGH BACK**    **BACK TO FLOOR**  
W: 500    Lowest: 1170  
H: 720    Highest: 1230

**SEAT**    **SEAT TO FLOOR**  
W: 510    Lowest: 455  
D: 520    Highest: 515

**ARM TO FLOOR**  
Lowest: 640  
Highest: 770

Fabric: Lana carbon



VENTI-H



VENTI-L



back view

## Features:

Adjustable seat height  
Adjustable seat and back angle  
Adjustable weight tension  
Adjustable aluminium arms

High density foam  
Synchron mechanism with 3 locking positions  
700mm aluminium 5 star base

Available in local fabrics  
Suitable for indoor use only



# AVANTI RANGE

## INSTRUCTION OF USE

**INDOOR USE ONLY**

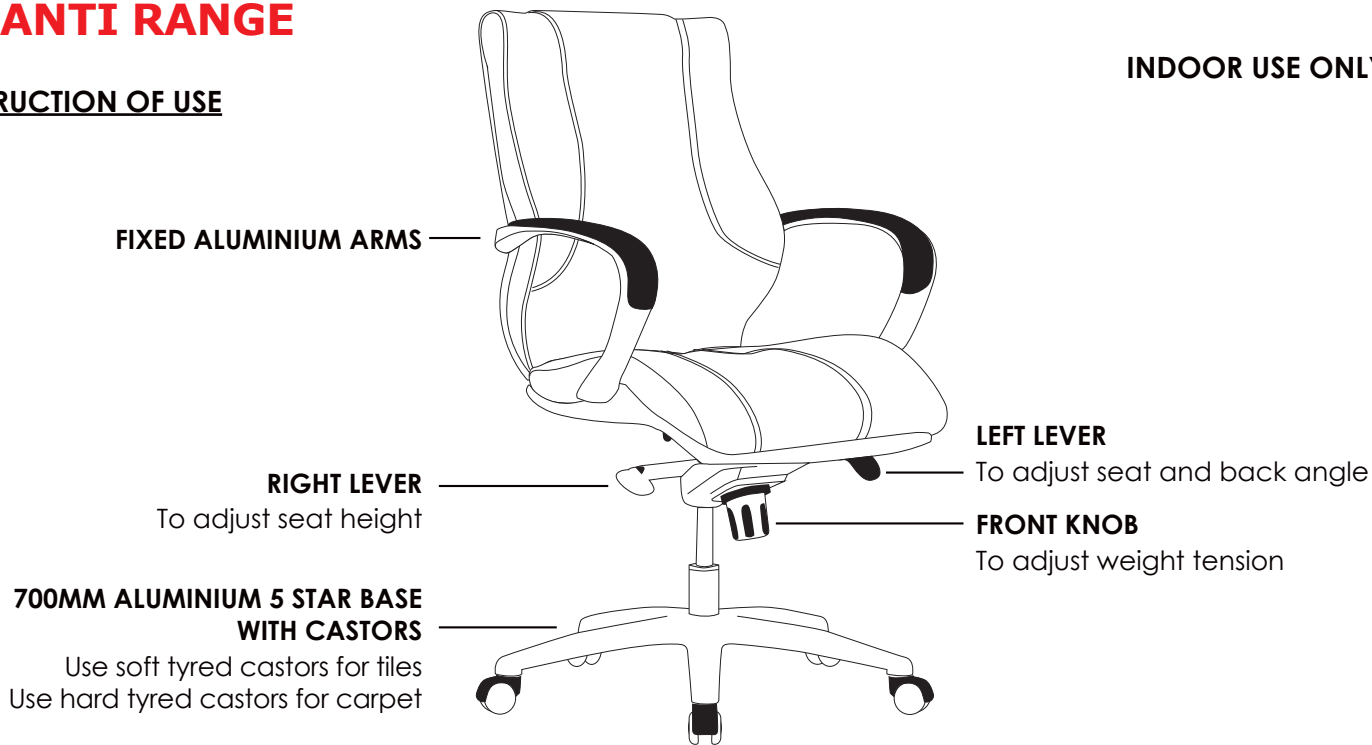

**X** Do not use as a step ladder

## DIMENSIONS: (mm)

**LOW BACK**    **BACK TO FLOOR**  
W: 500    Lowest: 1045  
H: 570    Highest: 1125

**HIGH BACK**    **BACK TO FLOOR**  
W: 500    Lowest: 1190  
H: 730    Highest: 1270

**SEAT**    **SEAT TO FLOOR**  
W: 510    Lowest: 510  
D: 530    Highest: 590

**ARM TO FLOOR**  
Lowest: 710  
Highest: 790

Fabric: Lana carbon



AVANTI-H



AVANTI-L



back view

Features:

Adjustable seat height  
Adjustable seat and back angle  
Adjustable weight tension  
Fixed aluminium arms

High density foam  
Knee tilt mechanism with 3 locking positions  
700mm aluminium 5 star base

Available in local fabrics  
Suitable for indoor use only



# KOMBO RANGE

INDOOR USE ONLY

## INSTRUCTION OF USE

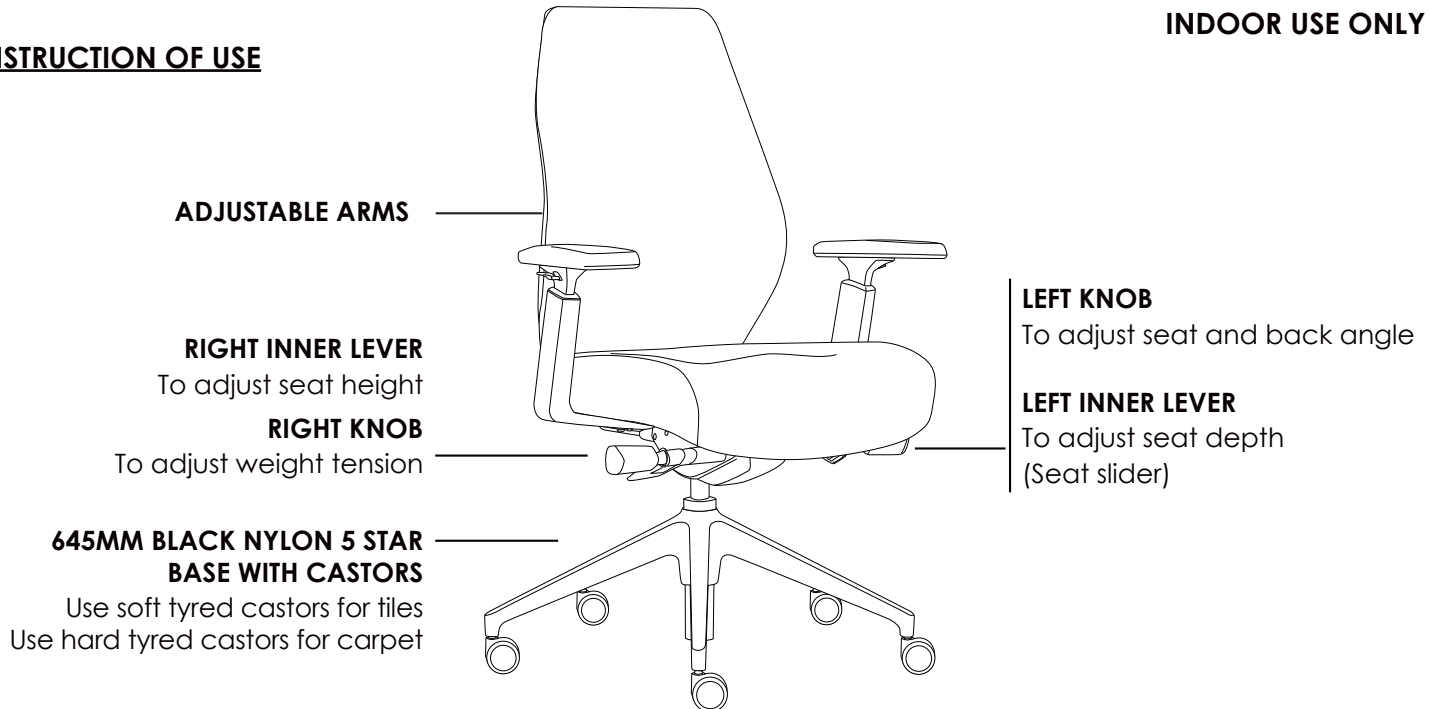

**X** Do not use as a step ladder

## DIMENSIONS: (mm)

<b>LOW BACK</b>	<b>BACK TO FLOOR</b>	<b>HIGH BACK</b>	<b>BACK TO FLOOR</b>	<b>SEAT</b>	<b>SEAT TO FLOOR</b>	<b>ARM TO FLOOR</b>
W: 520	Lowest: 1100	W: 520	Lowest: 1250	W: 515	Lowest: 470	Lowest: 660
H: 610	Highest: 1160	H: 760	Highest: 1310	D: 480	Highest: 530	Highest: 720



KOMBO-H



KOMBO-L



back view

## Features:

Adjustable seat height  
Adjustable seat and back angle  
Adjustable seat depth (seat slider)  
Adjustable weight tension

Adjustable arms  
Moulded back foam  
**Big boy seat**  
**Memory seat foam**

Synchron mechanism with 3 locking positions  
645mm black nylon 5 star base  
Available in local fabrics  
Suitable for indoor use only



# ASSIST RANGE

## INSTRUCTION OF USE

**INDOOR USE ONLY**

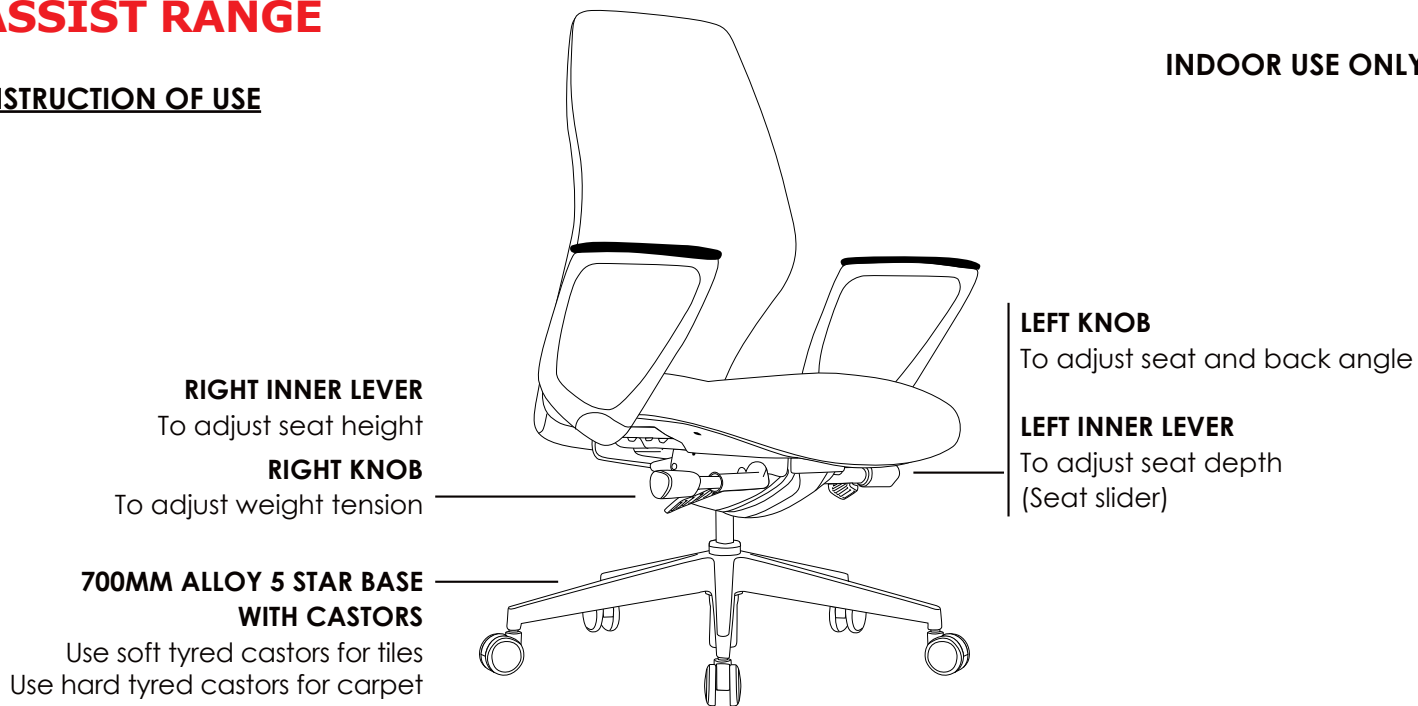

**X** Do not use as a step ladder

## DIMENSIONS: (mm)

**LOW BACK**    **BACK TO FLOOR**  
W: 520    Lowest: 1000  
H: 610    Highest: 1080

**HIGH BACK**    **BACK TO FLOOR**  
W: 520    Lowest: 1185  
H: 760    Highest: 1265

**SEAT**    **SEAT TO FLOOR**  
W: 520    Lowest: 450  
D: 520    Highest: 530

**ARM TO FLOOR**  
Lowest: 650  
Highest: 710



ASSIST-H



ASSIST-L



back view

## Features:

Adjustable seat height  
Adjustable seat and back angle  
Adjustable seat depth (seat slider)  
Adjustable weight tension

Fixed aluminium arms  
Plastic under pan  
Moulded seat and back foam  
Synchron mechanism with 3 locking positions

700mm alloy 5 star base  
Available in local fabrics  
Suitable for indoor use only



## FOCUS RANGE



FOC-1U



FOC-1UA

---

### DIMENSIONS: (mm)

BACK	SEAT	OVERALL	ARM WIDTH	TABLET ARM	ARM TO FLOOR	TABLET ARM TO FLOOR
W: 490 H: 435	W: 465 D: 440	H: 840 D: 550 W: 525	Inner: 510 Outer: 610	W: 610 D: 660	H: 680	H: 745 Flip up: 1010



FOC-1UTR



FOC-1UTL

Features:

Multi purpose stackable client chair  
 Not stackable with tablet arms  
 Optional black metal trolley  
 Linkable except with arms or tablet arm  
 Fully strengthened plastic back shell

Fully welded frame  
 BIFMA drop tested  
 Available in local fabrics  
 Suitable for indoor use only  
 Do not use as a step ladder

WARRANTY 4 Year  
 WEIGHT LIMIT 120 Kilogram  
 UPHOLSTERED IN AUSTRALIA  
 BIFMA



# VINN RANGE



VINN-BU



VINN-BUA



VINN-BUT



VINN-BU-ST

Available with arms

## DIMENSIONS: (mm)

BACK	SEAT	OVERALL	STOOL OVERALL	ARM WIDTH	ARM TO FLOOR	TABLET ARM	TABLET ARM TO FLOOR
W: 435 H: 390	W: 455 D: 435	H: 830 D: 545 W: 530	H: 1030 D: 540 W: 555	Inner: 485 Outer: 570	H: 665	W: 380 D: 290	H: 695 Flip up: 900

Fabric: Chelsea camilia



VINN-MBU



VINN-MBUA



VINN-MBUT



VINN-MBU-ST

### Features:

- Stackable
- Not stackable with tablet arms/stool with arms
- Optional black metal trolley
- Linkable except with arms or tablet arm
- Plastic under pan

- Solid steel sled base frame
- Available in local fabrics
- Suitable for indoor use only
- Do not use as a step ladder

Optional:



Colour mesh  
(Jazz mesh range)

Trolley available



<b>WARRANTY</b> <b>4</b> Year	<b>WEIGHT LIMIT</b> <b>120</b> Kilogram	<b>UPHOLSTERED</b> <b>IN AUSTRALIA</b> 
-------------------------------------	---	---

## POD RANGE



POD-B-NL



POD-R-BL



POD-W-BB



POD-B-BBC

### DIMENSIONS: (mm)

SHELL	NL/BL	NL/BL SEAT TO FLOOR	BB	BB SEAT TO FLOOR	BB BACK TO FLOOR	BBC	BBC SEAT TO FLOOR	BBC BACK TO FLOOR
H: 380	H: 810	H: 460	D: 520	Lowest: 410	Lowest: 760	D: 520	Lowest: 460	Lowest: 810
D: 400	D: 460	H: 460	W: 520	Highest: 530	Highest: 880	W: 520	Highest: 580	Highest: 930
W: 425	W: 415							

Fabric: Lana carbon

Plastic colour option:

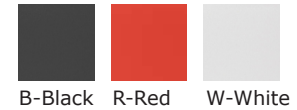

POD-RU-NL



POD-WU-BL



POD-BU-BB



POD-RU-BBC

### Features:

Not stackable  
Adjustable seat height  
(With black base and  
black base with castors only)

Available in local fabrics  
Suitable for indoor use only  
Do not use as a step ladder



Optional:



Plastic shell



With  
Upholstered

## POD RANGE



POD-4BU



POD-4RUA



POD-4WUT



POD-STBU

### DIMENSIONS: (mm)

SHELL	STOOL OVERALL	ARM WIDTH	TABLET ARM	4 LEG: OVERALL	WITH ARM TO FLOOR	SLED: OVERALL	WITH ARM TO FLOOR
H: 380	H: 1025	Inner: 440	W: 380	H: 820	H: 660	H: 830	H: 670
D: 400	D: 530	Outer: 540	D: 280	D: 510	<b>WITH TABLET ARM TO FLOOR</b>	D: 530	<b>WITH TABLET ARM TO FLOOR</b>
W: 425	W: 500			W: 470	H: 700	W: 480	H: 710
					Flip up: 980		Flip up: 990

Plastic colour option:

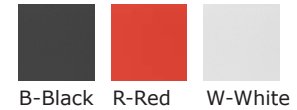

POD-SRU



POD-SWUA



POD-SBUT

## Features:

Stackable  
Not stackable with arms or tablet arm  
Linkable with sled base  
(Except with arms or tablet arm)

Plastic under pan  
Available in local fabrics  
Suitable for indoor use only  
Do not use as a step ladder



# MAXI RANGE



M1



M1-C



M4



M4-C

## DIMENSIONS: (mm)

BACK	SEAT	4 LEG SEAT TO FLOOR	4 LEG BACK TO FLOOR	4 LEG OVERALL	SLED SEAT TO FLOOR	SLED BACK TO FLOOR	SLED OVERALL	4 LEG ARM TO FLOOR	SLED ARM TO FLOOR
W: 440 H: 370	W: 460 D: 490	H: 465	H: 810	H: 810 D: 460 W: 520	H: 470	H: 805	H: 805 D: 620 W: 570	H: 630	H: 630

Fabric: Chelsea gazebo



MM1



MM1-C



MM4



MM4-C

Features:

Stackable  
(Sled base with no arms only)  
Plastic under pan  
Plastic outer back  
(upholstered back only)

Available in local fabrics  
AFRDI approved to level 6  
Suitable for indoor use only  
Do not use as a step ladder



Optional:



Colour mesh  
(Jazz mesh range)



Fixed arm

# VERA RANGE



VC100



VC100-C



VC400



VC400-C

## DIMENSIONS: (mm)

ROUND BACK	SQUARE BACK	SEAT
W: 450	W: 450	W: 450
H: 330	H: 380	D: 460

## 4 LEG:

WITH ROUND BACK OVERALL	WITH SQUARE BACK OVERALL	ARM TO FLOOR	SEAT TO FLOOR
H: 800	H: 850	H: 650	H: 480
D: 490	D: 490		
W: 495	W: 495		

TABLET ARM TO FLOOR
H: 770
Flip up: 1045

## SLED:

WITH ROUND BACK OVERALL	WITH SQUARE BACK OVERALL	ARM TO FLOOR	SLED TABLET ARM TO FLOOR
H: 800	H: 850	H: 650	H: 770
D: 625	D: 625	<b>SEAT TO FLOOR</b>	Flip up: 1045
W: 520	W: 520	H: 480	



OGVC100



OGVC100-C



OGVC400



OGVC400-C



Features:

Stackable  
Not stackable with arms or tablet arm  
Heavy duty metal frame

Available in local fabrics  
Suitable for indoor use only  
Do not use as a step ladder

Optional:



With arm



With left tablet arm



With right tablet arm

# MAXI BEAM

Optional:



Fully Upholstered back



Mesh back



Colour mesh with mesh back (Jazz mesh range)

WEIGHT LIMIT  
**200**  
Kilogram



M-BEAM 2

WEIGHT LIMIT  
**300**  
Kilogram



MM-BEAM 3

WEIGHT LIMIT  
**350**  
Kilogram



M-BEAM 4



## Features:

Plastic under pan  
Plastic outer back (upholstered back only)  
Black metal frame

Adjustable feet  
Available in local fabrics  
Suitable for indoor use only  
Do not use as a step ladder

## DIMENSIONS: (mm)

**BEAM 2**  
W: 1190  
H: 830  
D: 660

**BEAM 3**  
W: 1720  
H: 830  
D: 660

**BEAM 4**  
W: 2170  
H: 830  
D: 660

**SEAT TO FLOOR**  
H: 430

# FOCUS BEAM

WEIGHT LIMIT  
**200**  
Kilogram



F-BEAM 2U

WEIGHT LIMIT  
**300**  
Kilogram



F-BEAM 3U

## Features:

Fully welded black metal frame  
Twin seat support bars  
Adjustable feet

Available in local fabrics  
Suitable for indoor use only  
Do not use as a step ladder

## DIMENSIONS: (mm)

**F-BEAM 2U**  
W: 1020  
H: 890  
D: 570

**F-BEAM 3U**  
W: 1570  
H: 890  
D: 570

**SEAT TO FLOOR**  
H: 410



# VINN BEAM

Optional:



Upholstered  
Plastic back



Mesh back



Colour mesh  
with mesh back  
(Jazz mesh range)

WEIGHT LIMIT  
**180**  
Kilogram



V-BEAM 2U

WEIGHT LIMIT  
**250**  
Kilogram



V-BEAM 3MU

WEIGHT LIMIT  
**300**  
Kilogram



V-BEAM 4U



## Features:

Heavy duty black metal frame  
Black plastic  
Adjustable feet

Available in local fabrics  
Suitable for indoor use only  
Do not use as a step ladder

## DIMENSIONS: (mm)

**BEAM 2**  
W: 1060  
H: 825  
D: 510

**BEAM 3**  
W: 1530  
H: 825  
D: 510

**BEAM 4**  
W: 2020  
H: 825  
D: 510

**SEAT TO FLOOR**  
H: 455

# POD BEAM

Plastic colour option:



WEIGHT LIMIT  
**200**  
Kilogram



P-BEAM 2BU

WEIGHT LIMIT  
**300**  
Kilogram



P-BEAM 3RU

WEIGHT LIMIT  
**350**  
Kilogram



P-BEAM 4WU

## Features:

Heavy duty black metal frame  
Adjustable feet  
Available in local fabrics

Suitable for indoor use only  
Do not use as a step ladder



## DIMENSIONS: (mm)

BEAM 2	BEAM 3	BEAM 4	SEAT TO FLOOR
W: 1060	W: 1530	W: 2020	H: 475
H: 825	H: 825	H: 825	
D: 510	D: 510	D: 510	

# SMOKE RANGE



SMOKE-4L



SMOKE-SB



SMOKE-SBB



SMOKE-AB

## DIMENSIONS: (mm)

SHELL	4L	4L SEAT TO FLOOR	SB/SBB	SB/SBB SEAT TO FLOOR	NL/BL	NL/BL SEAT TO FLOOR	AB SEAT TO FLOOR	BB SEAT TO FLOOR	BBC SEAT TO FLOOR
H: 410	H: 830	H: 455	H: 830	H: 455	H: 800	H: 410	Lowest: 445	Lowest: 425	Lowest: 475
D: 400	D: 500		D: 490		D: 520		Highest: 560	Highest: 545	Highest: 595
W: 470	W: 530		W: 530		W: 520		AB BACK TO FLOOR	BB BACK TO FLOOR	BBC BACK TO FLOOR
							Lowest: 820	Lowest: 815	Lowest: 865
							Highest: 935	Highest: 935	Highest: 985



SMOKE-NL



SMOKE-BL



SMOKE-BB



SMOKE-BBC

## Features:

Adjustable seat height  
(With 4 star base, black base and  
black base with castors only)

Fully upholstered  
High density foam  
Plywood shell

Available in local fabrics  
Suitable for indoor use only  
Do not use as a step ladder



# SAL RANGE



SAL



side view



back view

## Features:

Fully upholstered  
High density foam  
Black metal frame

Available in local fabrics  
Suitable for indoor use only  
Do not use as a step ladder

## DIMENSIONS: (mm)

OVERALL	BACK	SEAT	SEAT TO FLOOR
H: 695	W: 590	W: 625	H: 415
D: 645	H: 365	D: 350	
W: 670			



# LUSH RANGE



LUSH



side view



back view

## Features:

Fully upholstered  
High density foam  
Black metal frame

Available in local fabrics  
Suitable for indoor use only  
Do not use as a step ladder

## DIMENSIONS: (mm)

OVERALL	BACK	SEAT	SEAT TO FLOOR
H: 820	W: 525	W: 620	H: 430
D: 745	H: 385	D: 530	
W: 680			



# CUPPA RANGE



CUPPA



side view



back view

## Features:

Fully upholstered  
High density foam  
Black metal frame

Available in local fabrics  
Suitable for indoor use only  
Do not use as a step ladder

## DIMENSIONS: (mm)

OVERALL	INNER	SEAT	SEAT TO FLOOR
H: 795	<b>WIDTH</b>	W: 705	H: 460
D: 680	W: 550	D: 520	
W: 780			



# VERO RANGE



VERO-STB



VERO-STT



VERO-CHB



VERO-CHT

## Features:

Plywood inner structure  
Metal frame  
High density foam

Available in local fabrics  
Suitable for indoor use only  
Do not use as a step ladder

## DIMENSIONS: (mm)

**STOOL  
OVERALL**  
H: 910  
D: 500  
W: 485

**STOOL  
SEAT TO  
FLOOR**  
H: 680

**CHAIR  
OVERALL**  
H: 750  
D: 680  
W: 560

**CHAIR  
SEAT TO  
FLOOR**  
H: 430



# GOLD RANGE



GOLD-4L



GOLD-SB



GOLD-SBB



GOLD-AB

## DIMENSIONS: (mm)

SHELL	4L	4L SEAT TO FLOOR	SB/SBB	SB/SBB SEAT TO FLOOR	NL/BL	NL/BL SEAT TO FLOOR	AB SEAT TO FLOOR	BB SEAT TO FLOOR	BBC SEAT TO FLOOR
H: 400	H: 800	H: 490	H: 810	H: 500	H: 790	H: 430	Lowest: 400	Lowest: 445	Lowest: 495
D: 440	D: 540		D: 540		D: 520		Highest: 480	Highest: 565	Highest: 615
W: 640	W: 640		W: 640		W: 640		AB BACK TO FLOOR	BB BACK TO FLOOR	BBC BACK TO FLOOR
							Lowest: 780	Lowest: 805	Lowest: 855
							Highest: 860	Highest: 925	Highest: 975



GOLD-NL



GOLD-BL



GOLD-BB



GOLD-BBC



Features:

Adjustable seat height  
(With 4 star base, black base and  
black base with castors only)

High density foam  
Plywood shell  
Available in local fabrics

Suitable for indoor use only  
Do not use as a step ladder

# JUNE RANGE



JUNE



side view



back view

## Features:

Adjustable seat height  
High density foam  
700mm aluminium 4 star base  
Plywood shell

Available in local fabrics  
Suitable for indoor use only  
Do not use as a step ladder



## DIMENSIONS: (mm)

SHELL	INNER WIDTH	SEAT TO FLOOR	BACK TO FLOOR
H: 365		Lowest: 465	Lowest: 745
D: 480	W: 435	Highest: 600	Highest: 880
W: 560			

# TIME RANGE



## Features:

Adjustable seat height  
 (With black base and black  
 base with castors only)  
 High density foam  
 Moulded back foam

Plywood shell  
 Available in local fabrics  
 Suitable for indoor use only  
 Do not use as a step ladder

### DIMENSIONS: (mm)

<b>SB/SBB</b>	<b>NL/BI</b>
H: 755	H: 760
D: 500	D: 520
W: 640	W: 640
<b>SEAT TO FLOOR</b>	<b>SEAT TO FLOOR</b>
H: 450	H: 440

### **BB SEAT TO FLOOR**

Lowest: 455  
 Highest: 575

### **BB BACK TO FLOOR**

Lowest: 775  
 Highest: 895

### **BBC SEAT TO FLOOR**

Lowest: 505  
 Highest: 625

### **BBC BACK TO FLOOR**

Lowest: 825  
 Highest: 945



# OPERA RANGE



OPERA-4L



OPERA-TL



OPERA-AB

## Features:

- Loose back and seat cushions
- Moulded foam on steel frame
- Available in local fabrics
- Suitable for indoor use only
- Do not use as a step ladder



## DIMENSIONS: (mm)

BACK CUSHION	SEAT CUSHION	4L OVERALL	SEAT TO FLOOR	TL OVERALL	SEAT TO FLOOR	AB OVERALL	SEAT TO FLOOR
H: 400	H: 510	H: 850	H: 440	H: 850	H: 440	H: 850	H: 480
W: 580	W: 540	D: 610		D: 670		D: 700	
		W: 740		W: 740		W: 740	

# LEAF RANGE



LEAF-L



LEAF-H

## LEAF-T

MDF white top

Chrome frame

Suitable for indoor use only



LEAF-T

### Features:

High density foam  
Loose back cushion  
Metal frame  
Adjustable feet

Available in local fabrics  
Suitable for indoor use only  
Do not use as a step ladder



### DIMENSIONS: (mm)

**LEAF-L  
OVERALL**

H: 830

D: 650

W: 880

**LEAF-H  
OVERALL**

H: 1240

D: 650

W: 880

**SEAT TO  
FLOOR**

H: 430

**TABLE  
OVERALL**

H: 610

D: 330

W: 470

# PLAY RANGE



PLAY-1



PLAY-2



## Features:

High density foam  
Solid timber frame  
Plastic legs

Available in local fabrics  
Suitable for indoor use only  
Do not use as a step ladder

## DIMENSIONS: (mm)

PLAY-1	PLAY-2
H: 425	H: 425
D: 430	D: 450
W: 430	W: 685



# OLA RANGE



OLA-T



OLA-R



OLA-S

## Features:

High density foam  
Solid timber frame  
Plastic legs

Available in local fabrics  
Suitable for indoor use only  
Do not use as a step ladder

## DIMENSIONS: (mm)

**OLA-T**  
H: 455  
D: 480  
W: 540

**OLA-R**  
H: 455  
Dia: 550

**OLA-S**  
H: 455  
D: 550  
W: 550



# CLIP RANGE



CLIP



## Features:

Zig zag steel spring  
Solid hardwood frame  
Webbed base  
Chrome legs

Available in local fabrics  
Suitable for indoor use only  
Do not use as a step ladder

## DIMENSIONS: (mm)

H: 410  
D: 600  
W: 720



# IMPRESS RANGE



IMPRESS-1



IMPRESS-2



IMPRESS-T

## IMPRESS-T

8mm Tempered glass top  
 Chrome legs  
 Suitable for indoor use only

### Features:

Moulded polyurethane foam  
 Solid hardwood frame  
 Zinc legs

Available in local fabrics  
 Suitable for indoor use only  
 Do not use as a step ladder

### DIMENSIONS: (mm)

IMPRESS-1	IMPRESS-2	IMPRESS-T
H: 680	H: 400	H: 400
D: 510	D: 610	D: 470
W: 590	W: 650	W: 600

# RADIUS RANGE



RADIUS-1



RADIUS-2



## Features:

Moulded polyurethane foam  
Zinc legs  
Available in local fabrics

Suitable for indoor use only  
Do not use as a step ladder

## DIMENSIONS: (mm)

H: 420  
Dia: 630



# BAR STOOLS



GAMMA



LIFT



VEGAS



FLOW

Gamma, Vegas features:

- Solid rod chrome frame
- Available in local fabrics
- Suitable for indoor use only
- Do not use as a step ladder

Lift, Flow features:

- Adjustable seat height
- Solid steel stain base
- Foot rest
- Available in local fabrics
- Suitable for indoor use only
- Do not use as a step ladder

## DIMENSIONS: (mm)

GAMMA	LIFT	VEGAS	FLOW
H: 695	H: 530-780	H: 980	H: 735-985
D: 480	D: 410	D: 520	D: 400
W: 460	W: 400	W: 510	W: 450



# BLITZ RANGE



BLITZ-U



side view



back view

## Features:

High density foam  
Zig zag steel spring  
Plywood frame  
Chrome feet

Available in local fabrics  
Suitable for indoor use only  
Do not use as a step ladder

## DIMENSIONS: (mm)

BACK	SEAT	SEAT TO FLOOR	OVERALL
W: 600	W: 610	H: 410	H: 750
H: 350	D: 525		D: 750
			W: 610



# TWIST RANGE

Fabric: Lana grey, lana fire



TWIST-OT



TWIST-SO



TWIST-SI

## Features:

High density foam  
Plywood frame  
Webbed base  
Chrome feet

Available in local fabrics  
Suitable for indoor use only  
Do not use as a step ladder

## DIMENSIONS: (mm)

**TWIST-OT**  
W: 930  
H: 425  
D: 740

**TWIST-SO**  
W: 950  
H: 750  
D: 760

**TWIST-SI**  
W: 940  
H: 750  
D: 760

**SO/SI  
SEAT TO FLOOR**  
425



# MONTAGE RANGE

WEIGHT LIMIT  
**390**  
Kilogram



MO-3S

WEIGHT LIMIT  
**260**  
Kilogram



MO-2S

WEIGHT LIMIT  
**130**  
Kilogram



MO-1S

## Features:

Pocket spring seat  
Loose cushions upholstered both sides  
Zig zag steel spring  
Webbed base  
Solid hardwood frame

Stainless steel feet  
Available in local fabrics  
Suitable for indoor use only

## DIMENSIONS: (mm)

MO-1S	MO-2S	MO-3S	ARM TO FLOOR
W: 835	W: 1400	W: 1970	655
H: 740	H: 740	H: 740	SEAT TO FLOOR
D: 790	D: 790	D: 790	475



# CONCEPT RANGE

Fabric: Lana carbon

WEIGHT LIMIT  
**360**  
Kilogram



CON-3

WEIGHT LIMIT  
**240**  
Kilogram



CON-2

WEIGHT LIMIT  
**120**  
Kilogram



CON-1

## Features:

High density foam  
Zig zag steel spring  
Plywood frame

Black metal arm and feet  
Available in all local fabrics  
Suitable for indoor use only



## DIMENSIONS: (mm)

CON-1	CON-2	CON-3
W: 688	W: 1285	W: 1885
H: 750	H: 750	H: 750
D: 810	D: 810	D: 810

**ARM TO FLOOR**  
605

**SEAT TO FLOOR**  
410

# SHELL RANGE

Shell fabric: Jack flame  
Cushion fabric: Bolton chili



SHELL-1S



SHELL-1SH



SHELL-2S



SHELL-2SH

## Features:



- Australian made
- High density foam
- Loose cushions upholstered both sides
- Timber frame
- Aluminum legs
- Available in local fabrics
- Suitable for indoor use only

## DIMENSIONS: (mm)

SHELL-1S	SHELL-1SH	SHELL-2S	SHELL-2SH	ARM TO FLOOR
W: 890	W: 920	W: 1490	W: 1510	730
H: 865	H: 1210	H: 865	H: 1210	<b>SEAT TO FLOOR</b>
D: 840	D: 840	D: 840	D: 840	500

# ACOUSTIC SCREENS

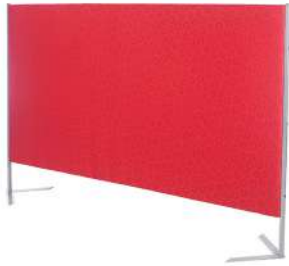

FAS-1218



FAS-1518



FAS-1818

## Features:

- Australian made
- Solid timber frame
- Frames wrapped with a 10mm layer of foam
- Frames wrapped with a layer of cardboard

- 19mm metal side frame
- Available in local fabrics
- Suitable for indoor use only

## DIMENSIONS: (mm)

FAS-1218	FAS-1518	FAS-1818
W: 1800	W: 1800	W: 1800
H: 1200	H: 1500	H: 1800



# STATE RANGE

## INSTRUCTION OF USE



ST003

### Features:

Adjustable seat height  
Optional glides or brake castors  
600mm black nylon 5 star base

Available in local fabrics  
Suitable for indoor use only  
Do not use as a step ladder

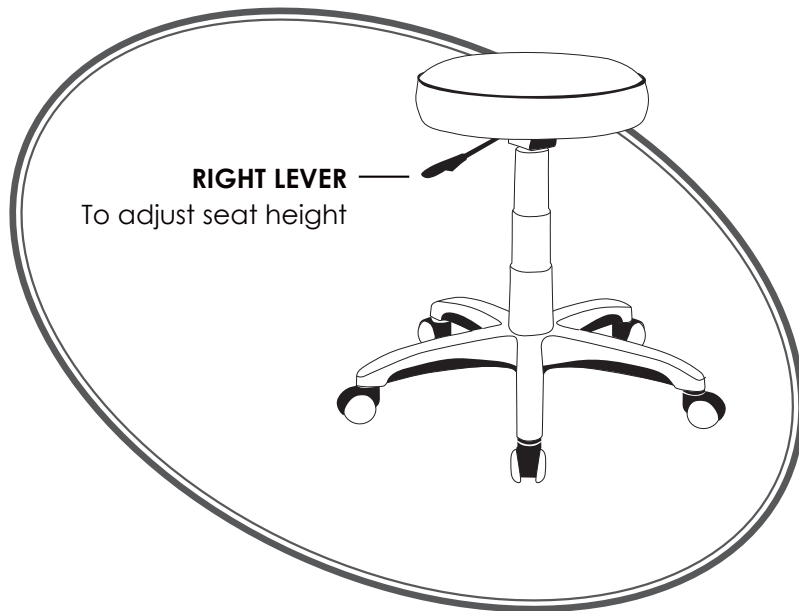

Optional drafting kit

### DIMENSIONS: (mm)

SEAT	SEAT TO FLOOR
Dia: 370	Lowest: 470
	Highest: 600

# FABRIC OPTIONS

\*Fabric card available, please contact our office for the copy

## JAZZ RANGE

## METRO RANGE



BLACK



MIDNIGHT



CHARCOAL



SILVER



METRO INK

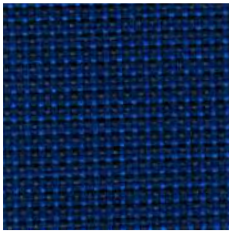

INDIGO

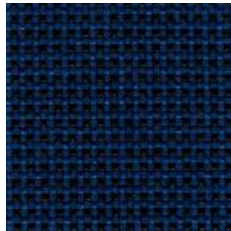

TURQUOISE

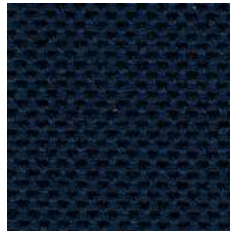

NAVY

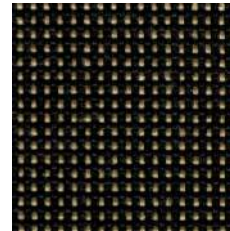

GOLD



METRO BLACK

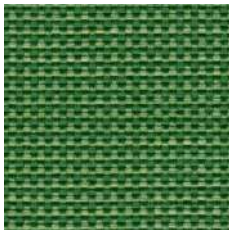

APPLE

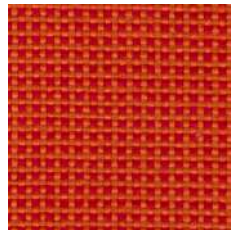

ORANGE

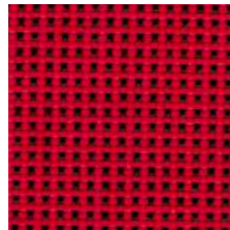

CRIMSON

## JAZZ MESH RANGE

---

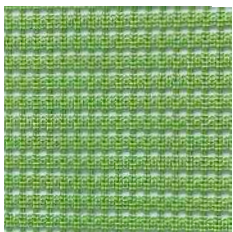

MINT

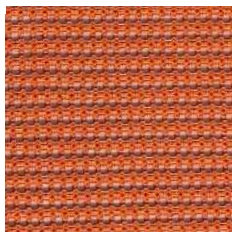

CITRUS

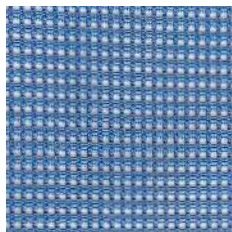

OCEAN



HOT

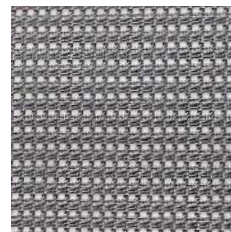

SLATE

## LOOP RANGE

---



AQUA



SEA



BLACK



MIST

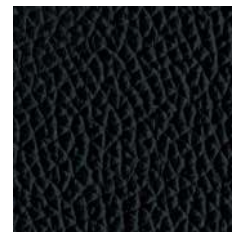

BLACK LEATHER

## SPADE RANGE

---



RED



TREE



LIME



DUST

## SPADE RANGE

## LANA WOOL RANGE

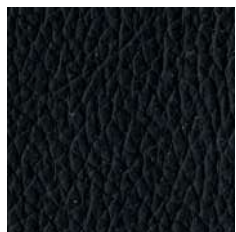

BLACK VINYL



STEEL



GREY

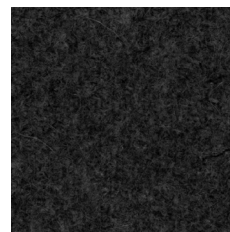

CARBON



SAND



RED VINYL



SKY



WAVE

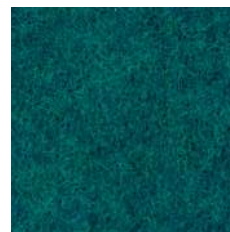

TEAL



SAPPHIRE



WHITE VINYL



WINE



FIRE



FOREST



# ASCOT

## COMMERCIAL

Ascot Commercial Group is a premier corporate and commercial interior design company in Australia.

With more than 40 years of experience in the design industry and a long list of clients, our consultants have the experience and resources to create functional, environmentally conscious and professional interiors for all industries. Our business is family managed and owned, and has a singular focus - to satisfy the needs of each of our valued customers - whether large or small.

Our custom design process<<http://www.ascotcommercial.com.au/process/>> has a consultative approach, and our interior designers work with you to design the best fitouts and furniture to suit your space.

Our team is comprised of some of the most accomplished professional interior design consultants Australia-wide, who understand the requirements of businesses in terms of fast turnaround, diligent service and results that represent a real value for money investment in the future of the business.

By designing with the individual business in mind, and sourcing quality products that fit with the design concept, Ascot Commercial produces stunning commercial interiors on time and on budget.

Whether you need a full office fitout with efficient workstations and boardroom tables or just a new reception desk to give your entrance a facelift, our designers have the perfect solution for every unique premise.

**T:** 1300 720 608

**E:** [sales@ascotcommercial.com.au](mailto:sales@ascotcommercial.com.au)

**W:** [www.ascotcommercial.com.au](http://www.ascotcommercial.com.au)

OFFICES MELBOURNE, SYDNEY, BURNIE